

DIELECTRIC 

SmartTech Modular Dehydrator 22000ST/33000ST

Instruction and operation manual

MODELS 2200ST / 33000ST SMARTTECH MODULAR DEHYDRATOR IB-430 REV. I PART NUMBER 100436



SPX 

**Notes, Cautions, and Warnings herein this manual
are used to prevent personal injury**

Warning: To reduce the risk of fire or electric shock, do not expose this equipment to rain or moisture. For Indoor use only.

Warning: If the equipment is used in a manner not specified herein, the protection provided by the equipment may be impaired.

Warning: Turn off Power, Isolate power by unplugging or by locking separate disconnect before servicing.

Warning!: High Voltage Disconnect Power before working within

Caution: This Unit may start automatically at any time

NOTE: All machinery must be fitted with means to isolate it from electrical energy sources. The isolator must be capable of being locked, when the operator is unable from any of the points to which he/she has access, to check that the energy is off!

Caution: Use care when lifting compressor as compressor weight exceeds 60 lbs. (27.3 kg)

ATTENTION: Observe Precautions for Handling Electrostatic Sensitive Devices

Important Safety Instructions

1. Read and follow all instructions
2. Keep these instruction with the equipment
3. Heed all warnings, cautions and notes.
4. Do not block any ventilation openings.
5. Install in accordance with SPX Dielectric instructions
6. Do not defeat the safety purpose of the grounding type plug
7. Protect the power cord from being walked on or pinched.
8. Use Wrist Strap when handling ESD Sensitive Circuit Boards

***WARNING! Risk of Electrocution
Isolate power by unplugging or by locking separate disconnect***



WARNING - RISK OR ELECTROCUTION



CAUTION - REFER TO ACCOMPANYING DOCUMENTS



WARNING - HOT SURFACE



ATTENTION - ELECTROSTATIC SENSITIVE DEVICE
OBSERVE PRECAUTIONS FOR HANDLING



CAUTION - LIFTING HAZARD



PROTECTIVE CONDUCTOR TERMINAL

FCC Part 15 Class B Notice

NOTE: This equipment has been tested and found to comply with the limits for a Class B digital device, pursuant to part 15 of the FCC rules. These limits are designed to provide reasonable protection against harmful interference in a residential installation. This equipment generates, uses, and can radiate radio frequency energy and, if not installed and used in accordance with the instruction manual, may cause harmful interference to radio communications. However, there is no guarantee that interference will not occur in a particular installation. If this equipment does cause harmful interference to radio or television reception, which can be determined by turning the equipment off and on. The user is encouraged to try to correct the interference by one or more of the following measures:

1. Re-orient or relocate the receiving antenna.
2. Increase the separation between the equipment and receiver.
3. Connect the equipment into an outlet on a circuit different from that to which the receiver is connected.
4. Consult the dealer or an experienced radio/TV technician for help.

CAUTION: Changes or modifications not expressly approved by the NRTL responsible for compliance could void the authority to operate the equipment.

**TABLE I
TABLE OF CONTENTS**

SECTION	TITLE	PAGE
1.0	Introduction	1
2.0	Feature Descriptions	1
2.1	Display Module	1
2.2	Sensor Module	2
2.3	Alarm/ATS Module	2
2.4	Cabinet Features	2
2.5	Compressor	2
2.6	Heatless Dryer	3
2.7	Humidity Sensor	3
2.8	Passive Air Intake	3
2.9	System Pressure Control	3
2.10	Water System	4
2.11	Optional Water Chiller	4
3.0	Description of Operation	4
4.0	Receiving and Inspection	6
5.0	Location Considerations and Recommendations	6
6.0	Installation	7
7.0	Preparation and Start Up	9
7.8	Post Start Up Observations	9
8.0	Setting and Adjustment Procedures	10
9.0	Scheduled Maintenance	12
10.0	Routine Service Checks	12
11.0	Maintenance Procedures	13
12.0	Alarms and Troubleshooting	15
12.1	Viewing Dryer Alarm Events	15
12.2	The Help Key	15
12.3	Maintenance and the ATS	15
12.4	Clear and Reset Alarm	15
12.5	High and Low Water Shutdown Alarm	16
12.6	High and Low Temperature Shutdown Alarm	16
12.7	Compressor Circuit Breaker Alarm	17
12.8	Power Loss/Brownout Fault Alarm	17
12.9	Humidity Alarm	17
12.10	Low System Pressure Shutdown Alarm	19
12.11	High system Pressure Shutdown Alarm	19
12.12	Low Line Pressure Alarm	19
12.13	High Line Pressure Alarm	20
12.14	ATS Standby Shutdown	20
13.0	Backup Bypass Operation	20
	Parts List for 22000ST and 33000ST Models	21 & 22

Figure No.	Figure Description	Page
1	Front view	cover
2	Air/Water Flow Schematic	5
3	Front view	23
4	Side view, cabinet open	24
5	Electrical enclosure	25
7	Rear view	26
8	Inside View	27
9	Heat Exchanger/Fan Compartment	28
10	Heatless Dryer	29
11	Purge Solenoid Valves	29

Table	Table Description	Page
I	Table of Contents	iv, v
II	Table of Leading Particulars	vi

Appendix	Description	Page
A	Alarm Connection Wiring	30
A	Alarm/ATS Interface Board	31
A	Sensor Board	32
C	Front Panel Display Features	34
C	SmartTech Menu Block Diagram	35
C	Setup Menu Block Diagram	36
D	Wiring Electrical Schematic	37
E	SmartTech Fusing and Circuit Protection	38
F	SmartTech Alarms	39-40
G	Power Termination and Grounding	41
H	Glossary of Terms	42

INCLUDED WITH MODELS 22000ST / 33000ST

Part number	Description	Quantity
0040151001	Cabinet Air Filter	4
36565	Intake Filter Element (one installed)	2
46222	Water Filter Element (one installed)	2
41125	3/4" NPT Check Valve (refer to Par. 6.5)	1
47744	Back flow check valve	1
0005538032	3/4" NPT Hex Nipple	2
0016853013	3/8" Poly flo 1/4" NPT Fitting	1

MAINTENANCE KITS, PARTS AND ACCESSORIES

100495	12 month maint. kit (contains 2 each of the three types of filters listed above, required each 12 mo. or 8000 hr.)
100496	24 month maint. kit (contains 2 purge solenoid valve overhaul kits, 1 water eject valve, and above 12 month kit, required each 24 mo. or 16000 hr.)
46632P	Automatic Transfer System is available to provide cycling between two with up to 8 dryers. When equipped with optional communications module, key personnel can access any Central Office from a remote personal computer via modem, and determine the overall status of the office.
105106	Floor Mounting Bracket Kit for securing Dehydrator Frame to the floor in Earthquake Zoned Areas.

TABLE II
TABLE OF LEADING PARTICULARS*

CHARACTERISTIC	MODEL 22000ST	MODEL 33000ST
Maximum Output	22,000 SCFD (25960 liters/hour)	33,000 SCFD (38935 liters/hour)
Compressor	DC12ST (2 per)	DC20ST (2 per)
Electrical Requirement	208-240V, 60Hz, 1Ph	208-240V, 60Hz, 3Ph
Operating Current	26.3 - 22.9 Amps	23.9 - 21.9 Amps
Control Circuit Breaker	3 Amp (2 per)	3 Amp (3 per)
Power Supply Circuit Time-Delayed Fuses	0.5 Amp, 5x20mm (2 per) 3 Amp, 5x20mm	0.5 Amp, 5x20mm (2 per) 3 Amp, 5x20mm (3 per)
Compressor Breakers	20 Amp, 2 pole	20 Amp, 3 pole
Height	71¾" (183cm)	71¾" (183cm)
Width	28¼" (72cm)	28¼" (72cm)
Depth	24" (61cm)	24" (61cm)
Weight	450lbs (204kg)	470lbs (213kg)

*Output characteristics based on standard air conditions of 70°F, 36% RH and 14.7 PSIA.

DRY AIR DEWPOINT	Below -40°F (below -40°C)
DESICCANT DRYER TYPE	DRY-PAK® twin-tower heatless dryer. Efficient, internal check-ball valving, purge controlled by Two-way solenoid valves.
OPERATING PRESSURE	DRY-PAK® and compressor 28 PSIG (193 kPa).
AIR COMPRESSOR TYPE	All models are equipped with a direct drive, high capacity, oil-less water sealed and cooled compressor.
REGULATED LINE PRESSURE	Adjustable to 25 PSI (172 kPa)
HUMIDITY ALARM	Fixed set point at 5%
LOW LINE PRESSURE ALARM	Adjustable to 25 PSI (172 kPa), 8 PSI (55 kPa) Factory Set
HIGH LINE PRESSURE ALARM	Adjustable to 25 PSI (172 kPa), 20 PSI (138 kPa) Factory Set
POWER ALARM	Active in event of service interruption, compressor or control-circuit breaker overload or unit turned off manually.

1.0 INTRODUCTION

1.1 This manual provides information to help you install, operate and maintain the Models 22000ST and 33000ST Compressor Dehydrators.

1.2 The overall design of the two models is the same. The difference between them is the size of their heatless dryer, the horse power and electrical characteristic of their compressors and their dry air output capacity. The Model 22000ST operates on single phase electrical service and has an output dry air capacity of 22,000 SCFD. The Model 33000ST operates on 3 phase electric service and has an output dry air capacity of 33,000 SCFD. All dehydrators supply an outlet air dew point of -40°F (-40°C) or lower.

1.3 These models contain several advances in air dryer design which will be of help to you in operating and in maintaining them. We recommend that you review the manual before installation, even if you are experienced with other designs.

1.4 Particular attention should be given to the start up procedure. There is a 5 second time delay between power on and actual start up. Section 2 will introduce you to the major improvements of the design. For those familiar with the Dielectric C.O. dehydrators, Section 2 will refresh your memory about some helpful characteristics carried forward to the present models.

1.5 Both models have two high-capacity water-sealed compressors and a self-regenerating DRY-PAK heatless drying module that operate well in harsh environments. However, providing a more moderate environment will improve performance, service life and will reduce maintenance requirements to a minimum.

2.0 FEATURE DESCRIPTIONS

ITEM	SECTION
Display Module	2.1
Sensor Module	2.2
Alarm/ATS Module	2.3
Cabinet Features	2.4
Compressor	2.5
DRY-PAK Heatless Dryer	2.6
Humidity Sensor	2.7
Passive Air Intake	2.8
System Pressure Control	2.9
Water System	2.10
Optional Water Chiller	2.11

2.1 DISPLAY MODULE

2.1.1 The SmartTech™ features an easy-to-read four line digital display and is backlit for low light installations. Under normal operating conditions, the air dryer is continuously displaying System Pressure, Line Pressure, Flow, %RH, Water Temperature and Air Temperature. Should an alarm occur, this display will show the primary alarm along with the date and time the condition occurred. A softkey Help Menu is available to assist with the diagnosis of the alarm condition.

2.1.2 Four softkey buttons are used to interface with the program to change operating parameters as well as reset alarms and access the Help Menu. The Setup Menu is used to set Date, Time, Start-up Delay, Line Pressure Alarms and High Flow Warning. See the Appendix for detail operation and menuing.

2.1.3 A large tricolored LED indicates the status of the Air Dryer and functions in the same way as the ATS 300 IUCs, Flashing Yellow indicates Start-up. Flashing Green/Yellow indicates Running and Alarm Disarming, Solid Green indicates Running with Alarms armed, Flashing Red and Green indicates Minor Dryer Alarm, Solid Red indicates Major Dryer Alarm, and Flashing Red indicates Manual Mode. Manual Mode is used while troubleshooting, performing maintenance or in an emergency situation.

2.2 SENSOR MODULE

2.2.1 The Sensor Module measures the System Pressure, Line Pressure, Air Flow, Humidity, and Incoming Voltage with its onboard sensors. External sensors for Low Water, High Water, and Water Temperature are wired directly into the sensor board.

2.2.2 The purge valve timing sequence (27 seconds purge with 3 seconds of dwell) and the cooling fan control circuits also reside with the Sensor Board. The fan comes on once the water temperature reaches 90°F otherwise it will be off especially if the optional Water Chiller Kit (P/N 101961) is installed.

2.3 ALARM/ATS MODULE

2.3.1 This module provides for alarm interfacing as well as ATS300 connections. (See Appendix A for additional detail).

2.3.2 Two summary alarm outputs and a 10 alarm segregation outputs are available for an Alarm Monitoring system. All outputs are dry contacts and isolated from one another and may be wired for open or closed in alarm. The Segregation Alarm is factory configured for closed in alarm but can be re-configured for open in alarm by moving two on-board jumpers. Termination is with dis-connectable terminal blocks for easy connection and removal. Summary alarm CO#1 may be configured for 540k Ohm/270k Ohm and 270k Ohm 0 Ohm Alarms.

2.3.3 Male and female D sub 9 position connectors are provided for ATS300/ATS300PLUS bus cable termination. This interface is built into the module so no additional external interfacing is needed. An on-board jumper is used to configure the last dryer connected. Addressing is accomplished through Menu-Setup.

2.3.4 A switch for Manual Dryer operation is provided to place the Dryer off-line with an ATS300/ATS300PLUS Transfer System and allow maintenance and troubleshooting capability. This switch function is like the one used on the ATS300 IUC interface panels.

2.4 CABINET FEATURES

2.4.1 The lower front panel of the Dehydrator is removed by lifting and then turning the two latches. Each side panel is held by four screws at the rear of the cabinet. The side panels can be removed when the screws are loosened. Move the panel sideways to clear the cabinet and push it forward to remove.

2.4.2 Never place objects on top of the dehydrator. It will interfere with the air flow of the cooling fan.

2.4.3 The front panel which contains the display and ON/OFF switch is also the access panel to the fuses and high voltage components. There is never a need to open this panel for routine maintenance. Observe warning labels and always disconnect the power supply to the dehydrator before opening this panel.

2.4.4 The cabinet acts as a cooling duct for the compressors and heat exchangers of the dehydrator. Excellent cooling is provided when the rear cabinet air filters are clean and all panels are in place. Do not operate the dehydrator for long periods with the panel removed.

--- NOTE ---

All machinery must be fitted with means to isolate it from electrical energy sources. The isolator must be capable of being locked where an operator is unable, from any of the points to which he/she has access, to check that the energy is still cut off! An External Surge Protection Device should be used when operating this device. This Equipment is suitable for Common or Isolated Bonding and for Network Telecommunication Facilities and locations where NEC applies.

2.5 COMPRESSOR

2.5.1 The SmartTech™ Dehydrator has two ST Watersealed Rotary Air Compressors. These compressors are a higher output capacity over prior compressor series and features a quick disconnect vertical manifold for easy removal without the need

for removing the air and water hoses. Also a handle has been added to help with moving and carrying.

2.5.2 Cleanliness of the water system and the air filters effect the service life of the compressor, as does the room temperature where the unit is installed. The most common reason for compressor repair is a gradual loss of output capacity, until it will no longer meet the output air requirement of the dehydrator. Often, continual service is experienced for several years before overhaul is needed. Very long periods of operation without servicing are not destructive.

2.5.3 We caution against the field repair of electric motors and recommend that if the compressor needs more work than a simple repair kit installation, it should be returned to Dielectric for repair.

2.5.4 Repair kits are easy to install when needed with the compressor removed from the dehydrator. Both minor and major repair kits contain a compressor installation procedure P/N 100832.

2.5.5 Performance can be fully restored by installation of a major repair kit. The compressors in all models use the same major repair kit (P/N 47328).

2.5.6 The minor repair kit (P/N 47325) will correct leaks from seals and gaskets, but will not totally restore full output air flow in compressors which have lost capacity. The minor repair kit fits all the models addressed in this manual.

2.6 DRY-PAK HEATLESS DRYER

2.6.1 The dehydrator contains a single, DRY-PAK heatless dryer module. The DRY-PAK dryer has two filtered, spring loaded desiccant towers. Air is directed through the towers by two large check balls which are contained within friction-free materials, but are easily removable for inspection. All manifolding is internal to the module. The DRY-PAK dryer can be easily removed or installed in minutes, without removing other assemblies.

2.7 HUMIDITY SENSOR

2.7.1 The humidity sensor is a single chip circuit that measures both Relative Humidity, and Air Temperature and signals with a calibrated digital output. A small sample of dry air from the venting of system control pressure passes over the sensor. Its fast response to changes in Relative Humidity makes it reliable in clearing humidity alarms and will be much faster compared to the salt sensor type technology. The sensor boards microprocessor processes the digital signal and displays % Relative Humidity and Air Temperature.

2.8 PASSIVE AIR INTAKE

2.8.1 The Passive Air Intake is designed specifically for use in central office dehydrators. It performs several helpful functions and has no moving parts, requires no maintenance or adjustment. The Passive Air Intake makes it possible to eliminate moving parts which have historically required additional maintenance and trouble shooting.

2.8.2 The Passive Air Intake is a nonrestrictive inlet air muffler and distributes a mixture of inlet air and purge air to the compressor. It catches the water splash when the dehydrator shuts down, so no check valves are needed, and the dehydrator System Pressure is automatically vented each time it stops.

2.8.3 The Passive Air Intake will catch all the splash from several shutdowns, one after another, but if you keep turning the dehydrator off and on, some water will finally run down the side of the canister. No naturally occurring situation will cause water loss, and repeated manual intervention will not cause a catastrophic failure.

2.9 SYSTEM PRESSURE CONTROL

2.9.1 System Pressure control is very important in any compressor-dehydrator, because it governs the quantity of air which the dryer must handle. If the pressure is too high, the output capacity of the dehydrator will be reduced and may not be adequate. If the System Pressure is too low the dryer will be

unable to maintain a low dew point, no matter what drying method is used.

2.9.2 The Models 22000ST and 33000ST contain a System Controller which maintains the correct System Pressure over the full outlet capacity of the dehydrator. The System Controller interrupts the outlet air flow during a humidity alarm and bypasses any surplus when the outlet air requirement is low.

2.9.3 The System Controller reacts to adjustment of the System Regulator. A System Flow Valve makes it simple to obtain the full capacity of the dehydrator without disconnecting the outlet air pipes.

2.10 WATER SYSTEM

2.10.1 It takes about two gallons of clean tap water to prime and fill the dehydrator water system. Water is used to cool the compressor and acts to seal the minute spaces between the port sleeve, the rotor and the housing. This sealing action is possible because of the high speed of the rotor. The water also acts as a lubricant on the rotor seal that separates the rotating rotor from the fixed housing. The fact that the water is the medium between the assembled parts together with a precise balance of mechanical forces, are the major reasons for the exceptionally long life of the compressor.

2.10.2 When air is compressed and then is cooled for use in a dryer, it is usually at or near saturation (100% relative humidity) regardless of the type of compressor used. The saturated air is not a problem to a well designed heatless desiccant dryer. Because the heatless dryer purges air just as wet as the air entering it, a balance is maintained over the designed temperature and flow range.

2.10.3 The components in the water system which require routine maintenance are the water filter, water ejector solenoid valve and the water float switches which are inside the Water Sight Tube.

2.10.4 A "Manual Water Eject Switch" has been included in the water system to aid in maintenance and in trouble shooting. The switch is visible when

the front cover is removed. The switch is clearly labeled and is located on the left side above the air intake filter.

2.11 OPTIONAL WATER CHILLER (P/N 101961 without flow control valve)

2.11.1 Both models may be equipped with a factory installed "Water Chiller". This option is offered for those sites where, due to building constraints, adequate ventilation or air conditioning are not practical alternatives and multiple dryers are required due to very high air flow requirements. The necessary coolant water flow may be provided by a recirculating cooled water system or by tap water.

2.11.2 The chiller option consists of an efficient flat plate water-to-water heat exchanger, flow-orifice, temperature indicator and related components. The chiller coolant flow is regulated by the flow-orifice. Termination of the chiller is at the rear of the dehydrator cabinet for easy hookup.

2.11.3 The dehydrator water circuit, (see paragraph 3.3), is kept totally isolated from the coolant water. The warmest water in the dehydrator is cooled by the chiller before it enters the dehydrators air cooled heat exchanger and flows to the compressor. The dehydrators operating environment thus is similar to its environment when operating in a much cooler room and its output capacity increases proportionally.

3.0 DESCRIPTION OF OPERATION

3.1 Air/Water Flow System (see Fig. 2)
Ambient air is drawn through the inlet air filter and through the Passive Air Intake, where it mixes with purge air returning from the heatless dryer desiccant towers.

3.2 The combined wet air then enters the compressors, where the pressure is raised to 28 PSIG and the air is mixed with the compressor cooling water. Water enters the compressors at a rate controlled by the water metering orifices. The compressed air and warmed water flows directly to the water separator

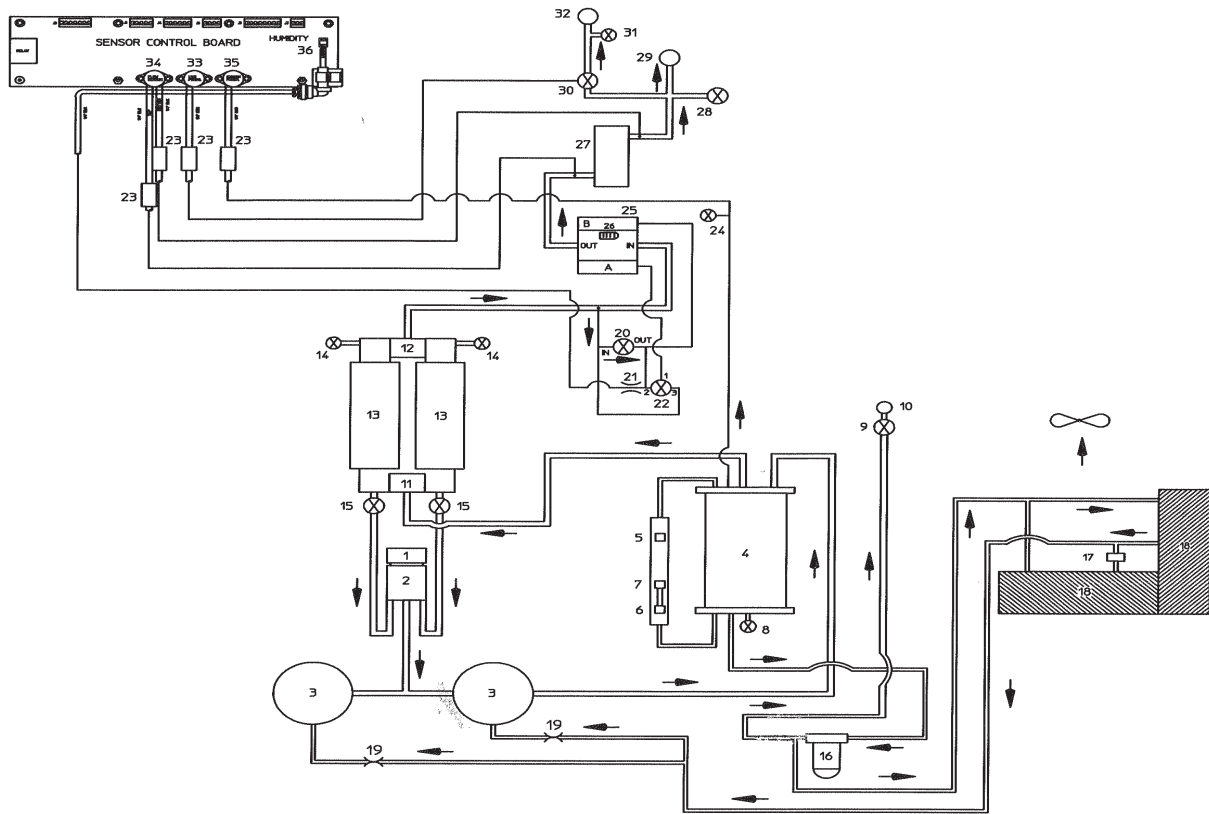

- | | | |
|-----------------------------------|---------------------------------|------------------------------|
| 1) INTAKE FILTER | 2) INTAKE DEFUSER | 3) AIR COMPRESSORS |
| 4) WATER SEPARATOR | 5) HIGH WATER SHUT-OFF FLOAT | 6) LOW WATER SHUT-OFF FLOAT |
| 7) WATER EJECT FLOAT | 8) WATER DRAIN PETCOCK | 9) WATER EJECT SOL. VALVE |
| 10) WATER EJECT OUTLET PORT | 11) DRYING TOWER INLET PORT | 12) DRYING TOWER OUTLET PORT |
| 13) DRYING TOWERS | 14) DRYING TOWER TEST PORTS | 15) PURGE SOLENOID VALVES |
| 16) WATER FILTER | 17) THERMISTOR (THERMAL SWITCH) | 18) AIR/WATER HEAT EXCHANGER |
| 19) WATER METERING ORIFICE | 20) SYSTEM CONTROLLER REGULATOR | 21) HUMIDITY DRY AIR VENT |
| 22) HUMIDITY SHUT-OFF PILOT VALVE | 23) DISCONNECT UNIONS | 24) SYSTEM PRESS TEST VALVE |
| 25) SYSTEM CONTROLLER | 26) BYPASS AIR MUFFLER | 27) FLOW CALIBRATION VALVE |
| 28) SYSTEM FLOW VALVE | 29) HIGH PRESSURE OUTLET PORT | 30) LINE PRESSURE REGULATOR |
| 31) LINE PRESSURE TEST PORT | 32) LOW PRESSURE OUTLET PORT | 33) LINE PRESSURE SENSOR |
| 34) FLOW CALIBRATION SENSOR | 35) SYSTEM PRESSURE SENSOR | 36) HUMIDITY SENSOR |

Figure 2
Air/Water Flow Schematic

tank without any restriction. Inside the separator tank, centrifugal action and large surface impingement separate the water from the air stream without significant pressure change.

3.3 Warm water flows from the base of the tank to the large water filter where any entrained solids are removed. The filtered water passes through the air cooled heat exchangers and is cooled to near ambient temperature. The temperature is monitored by a Thermister. The cooled filtered water flows unrestricted to the water metering orifice and again into the compressors. The water travels the entire route in about one minute.

3.4 Moist, pressurized air flows from the top of the water separator tank to the DRY-PAK dryer inlet check ball. The check ball is attracted to the open purge valve (left or right) selected by the cycle timer (which is part of the sensor board control).

3.5 The moisture content of the process air is reduced to a dew point of -40°F . (-40°C .) or lower, as it moves upward through the desiccant tower opposite the open purge valve. Any entrained water droplets drain into the purge valve fitting below the desiccant tower. The surplus moisture is retained temporarily in the desiccant.

3.6 A metered flow of dry purge air passes downward through the desiccant tower (the desiccant tower which has an open purge valve), picks up the moisture retained there in the previous cycle and carries it back to the Passive Air Intake. The surplus moisture is added to the water in the system when the purge air is again compressed (together with ambient air) and it flows to the water separator tank. The desiccant tower selection is reversed every thirty seconds of operation by the cycle timer.

3.7 The addition of surplus moisture to the water in the separator tank causes the water level in the sight tube to raise the water ejector float switch. This action in turn causes the water ejector solenoid valve to open and expel the surplus water through the water drain fitting on the rear of the cabinet.

3.8 Dry air flows from the heatless dryer outlet to the System Controller, which has a single pressure adjustment. The System Controller maintains the System Pressure, and also performs as both a Bypass Valve and a Humidity Shut Off Valve. The Bypass Air Muffler is located directly behind the body of the System Controller. The System Controller Regulator is adjustable and controls the pressure to the system controller. Venting dry air from the regulator controlled by a small fixed orifice is passed across the humidity sensor to measure the systems relative humidity. The system pressure is measured with a pressure sensor located on the Sensor Control Board.

3.9 The dry air flows next to the factory set flow valve that has a differential pressure sensor connected across it. The sensor located on the sensor board, measures the pressure and displays the corresponding flow in SCFD based on the calibration and Dryer size. The dry air is then fed to both the High Pressure Outlet and The Line Pressure Regulator. The output of the Flow Valve also supplies the System Flow Valve, which is used when adjusting the System Pressure Regulator. The Line Pressure Regulator adjustment controls the pressure which flows to the Low Pressure Outlet. The air flowing to the Low Pressure Outlet is monitored by a line pressure sensor located on the sensor board. High and Low Pressure Alarms are set in the Setup Menu.

4.0 RECEIVING AND INSPECTION

4.1 You have the responsibility to inform the carrier of any shipping damage and to initiate any damage claims. Do not accept containers showing obvious damage.

4.2 Immediately upon receipt, remove the air dryer from the shipping container. Thoroughly inspect the air dryer and file a claim against the carrier for any hidden damage.

5.0 LOCATION CONSIDERATIONS AND RECOMMENDATIONS

5.1 All electrical wiring must be in accordance with

local electrical codes and emergency power procedures. A 40-amp fused external listed disconnect box with 8 AWG power cable is required for the models 22000ST and 33000ST. The listed disconnect must be in close proximity to the Air Dryer and within easy reach of the operator. Also, the disconnect must be marked for the Air Dryer connected. A properly sized switch or circuit breaker must be included in the building installation. **NOTE:** Do not position the Air Dryer so that it is difficult to operate the disconnecting device.

For 22000ST..208-240V, 26.3-22.9A, 60Hz, 1 Ph

For 33000ST.208-240V, 23.9-21.9A, 60Hz, 3 Ph

A standard 115 VAC wall outlet is recommended for operation of power tools, drop cord and for a transfer controller.

5.2 Provide enough space for installation so that there will be at least 24 inches (more is fine) at the rear of the dehydrator for ventilation and access. Allow at least 36 inches at the front and sides for maintenance access.

5.3 A floor drain is needed to accept the ejected water from the water drain fitting. Install the provided water drain fitting using pipe sealant to the rear of the cabinet. The drain should be within 75 feet of the dehydrator. a 3/8-inch diameter plastic tube needs to be connected to the water drain fitting and routed to the water drain. The 3/8-inch water drain tube may be routed over a wall or other obstacles but it cannot be more than 15 feet above the water drain outlet port at any time. The drain tube must not be subjected to freezing or crimping.

5.4 The location should provide adequate space and ventilation for heat dissipation. The preferred ambient temperature range is 60°F to 90°F. Ambient humidity levels are of little consequence, but a clean environment prolongs component life. Do not place the air dryer where it may be subjected to freezing.

5.5 The unit is practically vibration free and bolting

to the floor is not required. A level floor location is recommended.

5.6 For models equipped with “Water Chiller” option only: The 1/4" NPT coolant water inlet and coolant water outlet are clearly labeled, on the rear of the cabinet. Make provision for the coolant water supply and the coolant water drain outlet. The use of rustproof brass quick connect, automatic shut-off, couplings (available from Dielectric) together with flexible hose is recommended. Provide safeguards against crimping, freezing and drain-back as instructed in 5.3 above.

Note: The number references with parenthesis throughout the remainder of the manual are the Parts List item numbers and are also the reference numbers found in pages 21 & 22.

6.0 INSTALLATION

6.1 Position the air dryer in accordance with the recommendations of Paragraph 5.2.

6.2 Lift and Turn inward the two door latches and remove the front panel.

6.3 A programmable delayed start time provides a fixed minimum delay of five seconds, so that the compressor sealing water will automatically prime the compressor before each start sequence. If the dehydrator is to be one of two or more operating at the same time, the delayed start time on the second dryer should be programmed with ten seconds of delay. Go to MENU - SETUP - Power on Delay to change delay. This will prevent power surges following service interruptions, or when switching to or from an emergency generator. It is recommended additional Air Dryers are separated by a minimum of 5 seconds. See Section 8 for Setup Menu.

6.4 Install a flexible water drain hose as described in paragraph 5.3. Hold the cabinet fitting with a second wrench while tightening the tube fitting.

6.5 Make flexible tube connections to the high and low pressure air outlet fittings (see fig.7 for loca-

tion). Two check valves with hex nipple fittings come packaged with the Air Dryer. If using only one Air Outlet, install the Check Valve marked with P/N 47744 Flow Restrictor Check Valve label at the outlet. NOTE: the direction of the large arrow indicates main airflow. This check valve has been modified with a small orifice to allow feedback of dry air into Standby Air Dryers that are on Transfer/Cycling Systems.

6.6 Verify that the Power Switch on the front control panel is in the OFF position. Locate the Alarm/ATS Interface Board and remove the battery insulation boot prior to turning on the Air Dryer. See Appendix A for battery location.



WARNING!

RISK OF ELECTROCUTION - Disconnect from electrical power before starting this procedure.

--- NOTE ---

An External Surge Protection Device should be used when operating this device. This Equipment is suitable for Common or Isolated Bonding and for Network Telecommunication Facilities and locations where NEC applies.

6.6.1 Instructions for Model 22000ST only: The 22000ST operates on 208-240 VAC, 1 Ph. power. Route the power cord (not provided) to a wall mounted listed electrical disconnect box, or alternately, install an appropriate twist lock connector on the cord and install a mating connector at the wall or on a free-hanging power cord. At the rear of the air dryer route the cable through the strain relief and into the power entrance box.

Connect the power cord BLACK lead to L1 of Terminal Board.

Connect the other BLACK lead (or WHITE lead with marker) to L2 of the Terminal Board.

Connect the GREEN lead to the Ground Stud. (see appendix "G" for proper grounding to the ground stud).

6.6.2 Instruction for Model 33000ST only:

The Model 33000ST operates on 208/240 VAC, 3 Ph. power. Route the power cord (not provided) to a wall mounted listed electrical disconnect box, or alternately, install an appropriate twist lock connector on the cord and install a mating connector at the wall or on a free-hanging power cord. At the rear of the air dryer, route the cable through the strain relief and into the power entrance box.

Connect the power cord BLACK lead to L1 of the Terminal Board.

Connect the BLUE lead (or white with blue marker) to L2 of the Terminal Board.

Connect the RED lead to L3 of the Terminal Board.

Connect the GREEN lead to the Ground Stud. (see appendix "G" for proper grounding to the ground stud)

6.6.3 The Power Switch (6) on the Front Control Panel **MUST REMAIN OFF until performing the start up procedure described in Paragraph 7.7.**

6.7 If the electrical supply voltage is 200 volts or lower, a purge valve malfunction may occur. See the Parts List for special solenoid coils for this particular installation.

6.8 Two CO summary alarm termination blocks are located at the rear of the Air Dryer. These are factory configured for either close or open circuit in alarm. Both are dry contact with a rating of up to 10 amps at 125 VAC and are isolated from each other for different monitoring systems. Two additional Alarm Options for CO#1 terminal block (only) may be user configured. The choice is 540K ohms clear with 270K ohms alarm indication or 270K ohm clear with 0 ohm (short) alarm indication. Two jumpers are easily set on the circuit board with the monitoring system wired to the common and CIA (closed in alarm) terminal block. See Appendix A for optional Alarm Configuration.

6.9 Segregated alarm connections are provided on a labeled terminal board on the rear of the cabinet. The output of this terminal board is dry contact, factory configured for close in alarm indication of each alarm function of the dehydrator, as indicated. For OPEN in alarm configuration, see Appendix A for optional Alarm Configuration.

6.10 If the dehydrator is to be part of an ATS controlled system you should verify the operation of the air dryer before connecting the unit to the controller. The ATS300 bus cable termination is with the DB9 male and female connectors on the back of the Air Dryer Interface Board. Connect the cable from the ATS300 or from another Air Dryer to the Input RS485 connector and then daisy chain another Air Dryer to the RS485 Output Connector. NOTE: The last Air Dryer in the chain requires a termination jumper indicating the last dryer. To configure the last dryer requires a Jumper to be installed on the Alarm/ATS Interface board. See Appendix A for ATS300 wiring. Refer to the ATS300 manual for complete installation and operating instructions.

6.11 For models equipped with “Water Chiller” option only: Connect a coolant water source, via a shut-off valve and tubing to the 1/4" FPT coolant water inlet on the rear of the cabinet. Connect a water drain line to the coolant water drain.

7.0 PREPARATION AND START UP

CAUTION

Do not operate the dryer before implementing the following water filling procedure!

7.1 Provide two gallons of clean tap water in a plastic jug. The plastic jug will help to prevent spilling when you pour the water, needed to prime the dehydrator.

7.2 Make sure the Front Panel **POWER** switch (6) is in the **OFF** position. Be sure that the compressor breakers (10), located on the front panel are in the up, “ON” position and that the manual operation switch on the Alarm/ATS interface board is OFF.

Verify that the power supply to the dehydrator is on.

7.3 Check to assure that the petcock (42) below the Water Separator Tank is closed securely.

7.4 Remove the red fill plug from the passive air intake and add water until the compressor intake hoses are full of water. Install the fill plug and turn ON the Power ON/OFF Switch. After the unit has run for two seconds turn the unit OFF.

NOTE: on Model 33000ST 3 phase units only, verify that the water flows towards the compressor. If the water flows towards the passive air intake, refer to paragraph 7.7.

7.5 Repeat the fill procedure in Paragraph 7.4 at least 2 or 3 more times. Note: that systems with the optional water chiller will require more water.

7.6 Allow the unit to run with an adjusted system pressure of 28 psig. See Section 8 for Display Setting and Adjustments.

7.7 **Model 33000ST Only:** Electrical phase sequence dictates motor rotation in the Model 33000ST. If the compressor did not accept water in 7.4 above, **TURN THE POWER OFF AT THE WALL FUSE OR BREAKER BOX WHICH SUPPLIES THE DEHYDRATOR.** Exchange the red lead and the black lead of the dehydrators power cable, where they are connected either at the wall disconnect box or in the male quick-connect electrical connector, if that method of electrical hookup is used. After replacing the cover of the electrical disconnect box or the quick-connect securely, restore the power supply. Return to paragraph 7.5 and perform the procedure as instructed.

7.8 POST START-UP OBSERVATIONS

Upon power up, the display will indicate the following sequences:

INITIALIZING (3 seconds); STANDBY (5 to 60 seconds depending on delay start-up setting); STARTING (30 seconds, LED flashing yellow); RUNNING DISARM (3 minutes, LED flashing

Green/Yellow); RUNNING (LED solid green).

The display will scroll the dryers operating parameters of System Pressure, Line Pressure, Flow, %RH, Water Temperature and Air Temperature. Pressing the "HOLD" key will freeze the display from scrolling. The "HOLD" will flash indicating the Hold Mode. Press again to continue scrolling. See Section 8 for Settings and Adjustments. See Appendix for details Menuing and description of Display and Key operations.

7.8.1 The System Pressure indication will probably be in the range of 28 to 30 PSIG depending on air flow, site elevation and the effect of the humidity alarm, if it is active. The dryer will automatically shut down if the humidity alarm remains active for approximately five minutes. If the unit is shut down by the Humidity Alarm Delay, just turn the Power switch off and on again to reset it.

7.8.2 When the Humidity Alarm remains cleared, adjust the Line Pressure Regulator (29) to accord with local practice. The result will be displayed on the LCD Display. NOTE: Press the HOLD button to freeze this display showing system pressure and line pressure while making adjustment.

7.8.3 Inspect the dehydrator for water leaks. If a leak is found, disconnect the electrical service before performing the corrective action. NOTE: These models are equipped with a thermal controlled fan that will not run until the water temperature is above 89°F.

7.8.4 When the dehydrator has been running for at least twenty minutes, check the water level in the water sight tube (24). If the water is below the center float switch, add water at the water fill fitting. Either turn off the Air Dryer and add water per Paragraph 7.4 or wait until a purge blast occurs and then quickly remove the red plug and fill with water for about 20 seconds, then replace plug before next purge blast. NOTE: The purge cycle occurs every 30 seconds so it's important not to leave the Filler Port open otherwise some water could splash out during the purge valve energizing. Overfill until the

Water Eject Float begins to rise (the middle float in the sight tube) and verify the lowering of the water level as water is ejected out through the Water Eject Solenoid Valve (8).

7.8.5 Verify that the cabinet air filters (46) are in place on the rear of the cabinet. After 20 minutes of operation, confirm the LCD Display with running, with no Alarms and a solid green led status indicating Running with an armed alarm circuit. Also recheck the system pressure adjust of 28-29 psig and readjust if required.

7.8.6 Verify the alarm wiring and monitoring system connection by causing a dryer alarm. Call your Alarm Center to confirm proper wiring and operation. NOTE: Minor Alarms like Low or High Pressure will automatically clear themselves. However, major alarms that cause Dryer shutdown need to be reset via the LCD display MENU - ALARM RESET - YES - EXIT. If the Air Dryer is a stand alone without an ATS, turning the Dryer OFF and back ON will also reset the major alarm. See Appendix C for display operations.

8.0 SETTINGS AND ADJUSTMENT PROCEDURES

Refer to the Appendix C for display and programming operation.

8.1 SETTING THE CURRENT TIME AND DATE

8.1.1 Press MENU, arrow down to SETUP, press OK. Select CURRENT TIME and press OK. Use the UP and DOWN arrows to increase and decrease the Hours. Use right arrow to select MINUTES. Use the UP and DOWN arrows to change the minutes. Press OK when done. The AM/PM indication will change as the hours pass by 12 o'clock. Dashed line below the digits indicates selection to be edited.

8.1.2 Arrow down and select CURRENT DAY and press OK. Use the UP and DOWN arrows to change the month. Use the right arrow to select DAY. Use the UP and DOWN arrows to change the DAY. Use

the right arrow to select the YEAR. Use the UP and DOWN arrow to change YEAR. Press OK when done. Dashed line below the digits indicates selection to be edited.

8.2 Setting the POWER-ON Delay (Default 5 seconds). NOTE: This setting allows staggered starting of Air Dryers in which there could be two or more operating in a central office. If using an ATS300Plus Transfer System on a UPS backup, the default setting of 5 seconds is okay for all dryers, as the ATS handles the delays. A minimum of 5 seconds up to 60 seconds can be set. It's recommended that at least a 5 second separation be programmed. There is a label located on the top cover where the set delay may be recorded. Press MENU, arrow down to SETUP, press OK. Select POWER-ON Delay and Press OK. Use the UP and DOWN arrows to increase and decrease the delay time. Press OK when done.

8.3 Setting the LOW LINE PRESSURE ALARM (Default 8 psi). Press MENU, arrow down to SETUP, press OK. Select, LOW LINE PRESSURE ALARM and Press OK. Use the UP and DOWN arrows to increase and decrease the pressure. Maximum value is 25 psi in 1 psi increments. Press OK when done.

8.4 Setting the HIGH LINE PRESSURE ALARM (Default 20 psi). Press MENU, arrow down to SETUP, press OK. Select HIGH LINE PRESSURE ALARM and press OK. Use UP and DOWN arrows to increase and decrease the pressure. Maximum value is 25 psi in 1 psi increments. Press OK when done.

8.5 Setting the HIGH FLOW Rate (Default 2000 SCFD above maximum capacity). NOTE: High flow rate is not an Alarm Condition, however, can be interpreted as a warning when reported at the Alarm Segregation Output and is Displayed as High Flow on the LCD Front Panel. Factory default is set above maximum dryer capacities. It's recommended before resetting this to allow the cable flow and pressure to stabilize and set a value above what is normal. Press MENU, arrow down to SETUP,

press OK. Select HIGH FLOW RATE and press OK. Use the UP and DOWN arrows to increase and decrease the flow increments of 1000 SCFD. Press OK when done.

8.6 The Brownout Setting (Default setting disabled). The Brownout Voltage is fixed at 180 volt and resets automatically at 190 volts. A Trip Delay of 2 seconds prevents nuisance tripping upon starting. To prevent the possibility of recycling on and off for an infinite period, a three strike rule has been programmed. After 3 concurrent unsuccessful attempts of starting the Air Dryer due to a brownout condition, a Brownout Fault is displayed and a Major Alarm is issued. This major alarm is resettable locally through the Display or remotely through the ATS300 PLUS. To enable the Brownout feature, Press MENU, arrow down to BROWNOUT and press OK. Use the down arrow and select the power-input configuration, WYE Phase, Delta Phase, or Single Phase 180°. NOTE: Verify the type of phasing provided to the dryer with your Electrician or power group before setting the Brownout feature. A single phase Air Dryer could be connected to two phases of a three phase Wye or Delta. If so, setup as Wye or Delta and not Single phase 180°. If unknown, leave the Brownout Setting disabled until confirmation.

8.7 Setting the ATS BUS ADDRESS (Default A1).

Press MENU, arrow down to SETUP, press OK. Arrow down to select ATS BUS ADDRESS and press OK. Use the UP and DOWN arrows to increase and decrease the assigned address. NOTE: Values will range from A1 through A8, B1 through B8, C1 through C8, D1 through D8, and E1 through E8. Channels B through E are only on ATS Series with expanded channels. Press OK when done.

NOTE: Should a SmartTech™ Air Dryer be the last Air Dryer in the BUS Cable series connection, the last DRYER must be configured as such on the Alarm/ATS Interface board. A black jumper on the board gets installed across the pins. See Appendix A for details.

8.8 ADJUSTING THE SYSTEM PRESSURE

8.8.1 The System Pressure Regulator (28) is located on the horizontal frame member. Before adjusting, wait until the front LCD displays the SYSTEM pressure and LINE pressure together, then immediately press the HOLD key to freeze the display.

8.8.2 Pull back on the System Pressure Regulator knob and slowly turn clockwise to raise or counterclockwise to lower the system pressure as viewed on the display.

8.8.3 Press the knob inward to lock setting. NOTE: The normal operating system pressure for the SmartTech™ series is a minimum of 28 psig. A slightly higher or lower setting will not effect the operation. Fluctuation in the system pressure will occur and are normal especially during the dwell cycle of the drying system. Make any final adjustments when the Air Dryer has come up to normal operating temperatures. Under a cold start after a dryer has been on standby, the system pressure could be 2 to 3 psi higher. DO NOT readjust as the pressure and flow will settle downward as the unit gets up to temperature. For higher altitudes, the operating system pressure can be lower to compensate for pressure and air density. As a guide line, for every 1000 feet elevation above sea level, a 1/2 psi reduction is recommended. This adjustment will help compensate for some of the lost output capacity due to elevation.

8.9 ADJUSTING THE LINE PRESSURE

8.9.1 The Line Pressure Regulator (29) is located on the horizontal frame member. Before adjusting, wait until the front LCD displays the System Pressure and Line Pressure together then immediately press the HOLD key to freeze the display.

8.9.2 Back off the lock nut on the Line Pressure Regulator and slowly turn clockwise to raise or counterclockwise to lower the line pressure as viewed on the display.

8.9.3 Tighten the lock nut to lock the setting. NOTE: for setting or verifying the High and Low alarms see paragraph 8.3 and 8.4.

9.0 SCHEDULED MAINTENANCE

NOTE: A 12-month scheduled maintenance kit, part number 100495 contains only the filters needed for each full year of operation. A 24 month scheduled maintenance kit, part number 100496 contains solenoid valve kits and the filters needed after two years of operation. To view the run hours of the Air Dryer press MENU and arrow down to VIEW RUN HOURS and press OK.

9.1 Each Six Months or 4000 hr.

9.1.1 Change Intake Filter (P/N 36565)

9.1.2 Change Cabinet Filter (P/N 0040151001)

9.1.3 Change Water Filter (P/N 46222)

9.2 Each Twelve Months or 8000 hours

9.2.1 Perform 9.1

9.3 Each Twenty Four Months or 16000 hours

9.3.1 Perform 9.1

9.3.2 Replace Water Ejector Solenoid Valve (P/N 36785)

9.3.3 Install Two Purge Valve Kits (P/N 0024815016)

10.0 ROUTINE SERVICE CHECKS

NOTE: It is recommended to place the Dryer in Manual Operation while doing routine maintenance, especially if connected to an ATS System. These operational checks can be performed on routine site inspections.

10.1 Check System Pressure: Verify that the system pressure is not below 28 psig.

10.2 Verify that the Line Pressure is set according to local practice.

10.3 Verify purge cycle each thirty seconds.

10.4 Visually check condition of water filter (40), inlet filter (31) and cabinet filter (46) for reasonable cleanliness.

10.5 Flush the water system by pressing the manual water drain switch. Depress the switch until the unit shuts down on low water shutdown. This verifies that the low water shutdown switch and the water eject valve are working properly. Turn off the dehydrator

on/off switch. Remove the water fill fitting from the passive air intake and add about one gallon of water to the system. Replace the water fill fitting to the passive air intake. Start the dehydrator. After the dehydrator has run for over a minute add water between purge blasts as needed until water is ejected. Replace the water fill fitting before the purge cycle ends. This verifies that the water eject switch is working properly.

11.0 MAINTENANCE PROCEDURES



WARNING: RISK OF ELECTROCUTION
– *Disconnect from electrical power before starting this procedure. 11.1*

11.1 While the dehydrator is running, press and hold the manual Water Eject Switch (18). When the dehydrator shuts down because of low water, turn the front panel power switch (6) OFF and disconnect from power source.

11.2 Turn the filter cap counterclockwise to remove the cap. Remove the old intake filter and center the new filter as the filter cap is tightened to the passive air intake assembly.

11.3 From the back of the dehydrator, remove the old cabinet filters from the cabinet. Slide the new filter into the cabinet slots, completely covering the heat exchanger fins.

11.4 CHANGING THE WATER FILTER

11.4.1 Place a container under the filter bowl (39) to catch about two cups of water. Remove the Water Filter bowl by turning it counter clock wise relative to the filter top housing (as seen from below the bowl).

11.4.2 Wipe the bowl clean with a rag. A very light coat of Vaseline on the sealing O-ring (41) will make installation and removal easier. Install the new filter element (40) and replace the filter bowl only hand tight. The O-ring seals the bowl to the filter top housing and overtightening makes the bowl difficult to remove in the future.

11.4.3 Remove the water fill fitting from the passive air intake. Add water until the wire reinforced hose from

the compressor to the passive air intake is full. Install the water fill fitting back onto the passive air intake.

11.4.4 Reconnect the electrical service to the dehydrator. Turn on the power switch to start the dehydrator. After the dehydrator has run for over a minute add water between purge blasts as needed until water is ejected. Replace the water fill fitting before the purge cycle ends.

11.4.5 After the dehydrator has run for over 5 minutes, verify that the water level is near the center float switch in the float tube assembly. Add water to the system if the water level is near the low water float switch. Avoid splash back of water by adding water to the system between purge blasts.

11.5 PURGE VALVE OVERHAUL

11.5.1 See fig. 9, page 27 for purge valve exploded view. Disconnect the harness wires from the purge valve coil (7) wire connectors. Release the coil retainer and set the coil aside. Loosen (do not remove) the hex nut at the base of the stainless steel core tube from which the coil was removed.

11.5.2 Remove the four hex bolts from the brass valve body and lift off the brass bonnet. Remove the diaphragm assembly, the core tube and the core tube o-ring. Install the new core tube o-ring and new core tube finger tight.

11.5.3 Remove the cardboard orifice protector from the new diaphragm assembly, hold the assembly with the core pointing upward. Be sure the small spring is positioned in the core with the spring cap (or the tightly wound end of the spring) protruding from the core. Place the bonnet and core tube down, over the diaphragm assembly, so that the small spring is securely captive.

11.5.4 There is a small orifice between the center and the edge of the diaphragm. Locate this orifice in the upper part of the valve body (the outlet side of the valve) and install the bonnet on the body. Tighten the four bolts first finger tight, then turn each one about 1/2 turn with a wrench, one after another, until each is tightened to about 120 inch pounds of torque. Tighten the core tube hex nut.

11.5.5 Restore the coil assembly and reconnect the coil wires to the harness receptacles.

11.6 CLEANING WATER SIGHT ASSEMBLY (Perform 11.1 first)

11.6.1 Disconnect the electrical quick connects above and below the sight tube assembly (24). Disconnect the blue and the red tubes by firmly pressing the ferrule toward the fitting while withdrawing the tube. Remove the two screws which hold the assembly to the top bracket then release the retainer clip.

11.6.2 Each end cap (21) may be removed from the Sight Tube (24) by turning it counterclockwise. Clean the float and tube assemblies with a rag and soapy warm water. Rinse thoroughly.

11.6.3 Be sure the O-rings (22) are in place and reassemble the Sight Tube Assembly and restore in reverse order.

11.7 COMPRESSOR REMOVAL

 **WARNING: RISK OF ELECTROCUTION**
– *Disconnect from electrical power before starting this procedure.*

 **WARNING: RISK OF BURNS**
– *Normal compressor operation will cause head temperature to exceed 212°F (100°C). Be very careful when handling a hot compressor.*

 **CAUTION: LIFTING HAZARD**
– *Compressor exceeds 60 lbs (27.3kg). Use care when lifting compressor.*

11.7.1 If the dehydrator is operating, push and hold the manual water eject switch (18) until the low water shutdown occurs. If the dehydrator can not be run, drain the water from the water separator tank by means of the petcock (42).

11.7.2 Remove the three hardware bolts that hold the quick disconnect manifold to the compressor. Lightly tap free the manifold from the compressor.

11.7.3 Loosen the quick release knob, disconnect the motor electrical connector and slide the compressor forward to remove.

11.7.4 Follow the procedure described in the compressor manual (P/N 10837), to rebuild the compressor.

11.7.5 Install the rebuilt or replacement compressor in reverse order. Remove the water fill fitting from the passive air intake. Add water until the wire reinforced hoses from the compressors to the passive air intake are full. Install the water fill fitting back onto the passive air intake. Turn on the power switch to start the dehydrator. After the dehydrator has run for over a minute add water between purge blasts as needed until water is ejected. Replace the water fill fitting before the purge cycle ends and check for any leaks around the manifold or pump housing.

11.8 DRY-PAK DRYER REMOVAL

11.8.1 Turn off the dehydrator and remove the front and left side panel from the cabinet.

11.8.2 Disconnect the main harness to the two purge solenoid valves. Disconnect the inlet and outlet hoses from the DRY-PAK dryer. Disconnect the two purge hoses from the purge solenoid valves.

11.8.3 Using a 7/16 inch wrench, remove the upper dryer bracket from the cabinet. Tilt the DRY-PAK dryer forward and lift up so the mounting studs clear the bottom bracket. The DRY-PAK dryer is now free to come out of the cabinet.

11.8.4 Install the DRY_PAK dryer into the dehydrator in the reverse order.

11.9 REPLACE SMALL 3-WAY SOLENOID VALVE

Water Eject, or Humidity Bypass Pilot

11.9.1 Disconnect the receptacle lugs from the coil.

11.9.2 Press the fitting ferrule firmly against each fitting and remove each tube.

11.9.3 Remove the solenoid valve from the assembly.

11.9.4 Transfer the fittings to the correct ports on the new three-way valve. Install the new valve back onto the assembly. Firmly push the 1/4" tubes back into the correct fittings to make leak proof connections. Reconnect the harness to the coil.

11.10 GENERAL CLEANING

11.10.1 Keep the unit free of dust and dirt. Using a general purpose cleaner, dampen a soft cloth and periodically wipe down the exterior surfaces.

12.0 ALARMS AND TROUBLESHOOTING

12.1 VIEWING DRYER ALARM EVENTS

12.1.1 The LCD will capture and display **only** the primary alarm that was the cause of the problem. Other alarms generated due to the primary one will not be displayed but will be indicated in the Segregated Alarm output. Besides the Alarm, a time and date stamp will also be captured to help with possible troubleshooting. Entries in to the Dryer Events Logs will hold up to 10 events of the latest occurrences for review. To access - Go to MENU, choose VIEW DRYER EVENTS, press OK. Use the UP and DOWN arrows to select #1 through #10 events. Number 1 event is the last event to occur.

12.2 THE HELP KEY

12.2.1 A HELP key will be shown on the display upon occurrence of an Alarm. Press the HELP key to access assistance for troubleshooting the primary alarm. Use the UP and DOWN arrows to select the possibilities. Press the MORE key for more information about that choice. Press EXIT to return to the previous MENU. Make another choice and hit the MORE key again. In most cases this will guide you to the most likely cause of the alarm. If not, call the Dielectric Technical Support Department with Model and date of Manufacture for additional support.

12.3 MAINTENANCE AND THE ATS

12.3.1 If the ST series Air Dryer is connected to an ATS300/300 Plus, turn ON the Manual Operation Switch located on the ATS/Alarm Interface Board at the rear of the Dryer. This will remove the Dryer from active or standby duty from ATS300 control. NOTE: The LCD will display MANUAL OPERATION and the LED will be flashing RED.

NOTE: For ATS300's it's okay to leave the BUS Cable connected. Removing them could disrupt Air Dryers that are located down the line. Once Maintenance or the alarm has been resolved, TURN OFF the MANUAL OPERATION switch.

NOTE: If troubleshooting alarms, it may be helpful to disconnect the ATS300 Plus 9-pin Bus Cable to isolate the fault.

12.3.2 In Manual Operation mode only, individual sensors may be selected for alarm override. It's recommended to select one at a time to help determine the root cause of the alarm, (i.e. - bad sensor).

CAUTION: Do not leave the air dryer unattended while operating in manual operation.

To override a sensor, go to MENU, Manual Operation, the display will prompt a message to toggle the Manual Operation Switch (located on the back of the Dryer on the Alarm/ATS Interface Board) to ON. Select which sensors to override and press OK to enter Manual Mode. NOTE: flipping the manual operation switch to ON first will automatically bring up the sensor selection screen without the prompt. Turning OFF the switch will exit manual operation and return the dryer to normal operation. The dryer will shutdown and then automatically restart and run through its start-up routine.

12.4 CLEAR AND RESET ALARM

12.4.1 To Clear and Reset an Alarm from the Display, press MENU, choose RESET DRYER ALARM, press OK – Press YES to reset the alarm and then press EXIT to return to the scrolling display. See 16Appendix "F" for Alarm Description and Timing for further information.

12.5 HIGH AND LOW WATER SHUTDOWN ALARM

12.5.1 High and Low Water Shutdown may result from an incorrect water level or from a component failure in the Water Sight Tube assembly (24). Watch the Sight Tube water level and restart the dehydrator. If the water level is high, push the Manual Water Eject switch (8). If this causes the water level to go down, clean or replace the double float switch (20). If the water level does not change, check for a crimped drain line outside the dehydrator. If the drain is OK, but the Manual Water Eject Switch will not cause the water level to go down, replace the Water Ejector Solenoid Valve (8).

12.5.2 If High or Low Water Shutdown occurs, but when restarted, the water level is normal (at or slightly below the center float switch) the top float switch (19) or the bottom (double) float switch (20) is at fault. To find out which switch has failed, disconnect the top float switch wire harness connector. An ohm meter will show continuity across the switch leads if the water is below the switch and the switch is OK. The switch should go open when the water lifts the float. If the top switch is OK, but malfunction continues, clean or replace the bottom (20) float switch.

12.5.3 If Low Water Shutdown occurs and the water level is low (at the bottom float switch of the double float switch assembly (20) when the dehydrator is restarted, Prime the dehydrator with water (paragraph 7.4). If the water level is below the center float switch and water is still ejected through the dehydrator drain, turn the POWER switch (6) OFF, disconnect one wire terminal (other than green wire) from the Water Ejector Solenoid Valve (8). Turn the POWER ON. If the water is still ejected, turn off the power, interrupt electric service to the dehydrator and replace the Water Ejector Solenoid Valve.

If instead the wire disconnect procedure stops the water loss, clean or replace the double float switch (20). Reconnect the wire to the Water Ejector Solenoid Valve, restore electrical service and restart the dehydrator.

12.5.4 If the water loss continues, look for a leak at the drain outlet fitting. Check for leaks under the compressor (25), under the Separator Tank (35), Water Filter (39), Water Sight Tube (24), Passive Air Intake (32) and finally in the Heat Exchanger (47). When searching for water leaks in areas where evaporation is high (where there is ventilation air flow), wrap the suspect fitting with a rag or with aluminum foil wrap. This will allow the moisture to collect and will help verify a leak if it is present.

12.6 HIGH AND LOW TEMPERATURE SHUTDOWN ALARM

12.6.1 High Temperature Shutdown will occur if the water temperature exceeds 160°F. while the dehydrator is operating. Verify that the room ventilation and/or air conditioning system is working properly. Correct as indicated.

12.6.2 An extremely dirty cabinet air filter (46) can restrict the flow of ventilation air through the heat exchanger and the cabinet. Replace the cabinet air filters and the water filter element (40).

12.6.3 With the water temperature above 89°F verify that the heat exchanger fan (12) is operating. The fan is visible from the top of the dehydrator. If the fan motor is inoperative, replace both the fan / motor assembly (12) and the capacitor (11).

12.6.4 If the fan and the filters are not at fault and High Temperature Shutdown persists, verify that the Water Separator Tank (35) is very hot. The temperature of the tank must reach approximately 160°F. (far hotter than normal) before a legitimate High Temperature Shutdown will occur. If the tank temperature is about normal (90 to 120°F.) but the condition continues, replacement of the thermistor assembly (17) is indicated.

12.6.5 If High Temperature Shutdown occurs and the above procedures have been performed, a very significant water flow reduction is indicated. Be sure that a water circuit tube is not crimped. If there is no tube restriction, the restriction is in the Metering Orifice which is located on the compressor fitting at

the end of the water return line. Use a piece of small wire or a pipe cleaner to clean the Water Metering Orifices.

12.6.6 A Low Temperature Shutdown will occur if the temperature of the water falls below 35°F. Typically a Standby Dryer would experience this condition from being exposed to the cold. Faulty ventilation systems in the winter time is one possible example. The SmartTech Dryer will automatically transition to a Major Alarm from Standby status should this occur.

12.7 COMPRESSOR CIRCUIT BREAKER ALARM

12.7.1 The compressor circuit breaker (10) may trip if the supply voltage is very low or very high. Usually voltage extremes also cause occasional chattering of the purge solenoid valves (7), early failure of water level float switches and associated electrical problems. If this seems the possible case, have the line voltage checked by a qualified electrician, while the dehydrator is operating.

12.7.2 If the supply voltage is proved to be correct, check the condition of the compressor electrical contactor (14). If the contacts are discolored or burned, replace the contactor. Use an amp meter to determine if the compressor load is greater than the circuit breaker (10) rating and replace the compressor (25) or the circuit breaker as indicated. To replace the contactors or Compressor Circuit Breakers, the front panel must be carefully lowered. Remove the seven (7) outer screws from the front panel and slowly lower the front panel by swinging outward while keeping the bottom edge against the outer frame members. DO NOT put excess weight on the front panel while it's in the down position. Replace the components as required and re-secure the front panel to the frame.

12.8 POWER LOSS/BROWNOUT FAULT ALARM

12.8.1 The Power Loss Alarm will be displayed if there is a low voltage condition or complete loss of electrical service. Once the power has been restored the dryer will restart automatically. NOTE: If an ATS300 system on a UPS backup is connected to the Dryer during a power failure, power from the ATS Bus Cables will provide backup power to the front display and POWER LOSS will be indicated.

This is also the case if the Dryer ON/OFF switch is left OFF. 12.8.2 If the Power Loss alarm is known not to be the result of an actual power interruption, and especially if it occurs repeatedly, an external wiring defect may be indicated. Have the power supply checked by a qualified electrician. It is possible for very high electrical spikes to exceed the spike suppression capability of the circuitry. Spikes may result from a faulty ballast or motor switch connected to the same power source. Loose or high resistance connections (or a faulty line circuit breaker) in the electric service to the dehydrator can also cause problems. Should a nuisance Power Loss Alarm or Brownout Fault occur due to a low voltage condition, it's recommended to have a qualified electrician monitor the AC lines with proper recording equipment to verify the problem.

12.8.3 A Brownout Fault is displayed only after 3 concurrent attempts to start. This is an major alarm and requires local or remote resetting.

12.8.4 For other power loss conditions refer to Appendix E for fusing and circuit protection information.

12.9 HUMIDITY ALARM

12.9.1 The humidity sensor, located on the Sensor Board, is a single chip circuit that measures both relative humidity and Air Temperature and signals with a calibrated digital output. A small sample of dry air from the venting of the system regulator pressure passes through a 1/4 OD tubing that surrounds the tip of the sensor. There is no wiring to the sensor. The Humidity alarm occurs should the Relative Humidity exceed 5%RH.

12.9.2 If there is a Humidity Alarm, the Display will first indicate the Time and Date of the Alarm, and show a Minor Alarm (Blinking Green/Red LED). If after 5 minutes of continuous operation in alarm, the Dryer status condition changes to a Major Alarm (solid Red LED) and shuts down. The bypass solenoid valve is de-energized and all air is bypassed out through the System Controller muffler. The Alarm Segregation and CO Alarms will be transmitted upon Humidity.

12.9.3 If in Humidity, restart the Dryer by resetting the Alarm or by turning the Power switch OFF then ON. Then remove the air hose from the sensor by depressing the ring collar on the white fitting and pulling off the hose. NOTE: Do not remove the fitting from the Sensor Board as the Humidity sensor could be damaged. Place the tip of a finger over the end of the hose and verify a slight movement of air.

12.9.4 If there is no air movement, the vent orifice located inside the tube (the one that has a tie wrap around it) and located close to the Humidity Bypass Solenoid Valve (9) is most likely plugged. It will need to be removed and replaced.

12.9.5 If the alarm persists after the previous steps have been performed, and the air is above 5%RH, there are five conditions which can cause a valid humidity alarm: low System Pressure, interrupted purge cycling, excessive compressor air flow capacity, restricted desiccant tower filters, or dirty/clogged purge adjusters.

12.9.6 Low System Pressure can cause a Humidity Alarm, but may not be obvious if the System Pressure is inaccurate. Test the accuracy of the System Pressure by connecting a test gauge to the test valve (24) located at the top of the Sight Tube assembly. Readjust the System Pressure if it is inaccurate. Verify that the System Pressure is correctly adjusted.

12.9.7 Interrupted Dry Pak (38) drying cycle can cause a Humidity Alarm. Test for correct dryer cycling by observing the System Pressure for fluctuation while listening for the purge sound each thirty seconds of operation. If cycling is interrupted, turn off the power switch (6), disconnect the dehydrator

from the electrical service and check the Purge Valve coils (7) by measuring the coil resistance while disconnected from the dehydrator electrical harness. Coil resistance should be 211 ohms +/- 15% (use an accurate digital meter). Replace the coil, if it's open or shorted.

12.9.7.1 If the coils are OK, but cycling is interrupted, reconnect the coils, connect electric service and restart the dehydrator. Check each coil for magnetic attraction to a very small steel screw driver, when it is held at the center of the clip which holds the coil in place. The light magnetic pull can be sensed for 27 seconds at one coil and three seconds later will be sensed on the coil of the opposite purge valve coil for 27 seconds. If the magnetic attraction is present as described, but cycling is interrupted, replace the Purge Valve kits (7). If neither coil displays a magnetic pull during a full minute of operation, check the condition of the circuit breaker which protects the timer circuit.

12.9.7.2 If the magnetic attraction is constant on one coil, replace the Sensor Circuit Board. If the magnetic attraction occurs only on one coil for 27 seconds, but not the other, check for open wire connections at the purge valve coil, and at the Sensor Board and if the wiring is not at fault, replace the Sensor Board.

12.9.8 Excess air flow capacity can cause a Humidity Alarm. If the cause of the humidity alarm is still unexplained after completing the preceding tests, increase the System Pressure 1 or 2 PSIG higher to provide extra purge air in the event that compressor capacity is exceptional. Call the factory for additional instructions to check compressor capacity and adjustment.

12.9.9 Tower restriction can cause a Humidity Alarm. If the humidity alarm persists and neither cycling interruption nor low System Pressure is the cause, measure the pressure at the test valve at the top of each desiccant tower with a test gauge (test gauge range minimum 30 PSIG) for a full minute. For 27 seconds of each minute, the pressure in alternate towers (purge pressure) should drop to 2.0 PSIG or less. If the purge pressure is somewhat higher, increase the System Pressure an equal amount.

12.9.10 If the Purge Flow is low (this is the portion of the dry air that is required from the drying tower to regenerate the off-line tower) then a humidity alarm will likely occur. To correct the problem, remove the Dry Pak towers from the Air Dryer, DO NOT readjust the Purge Adjuster. Remove the upper center block and soak the block with a degreaser/cleaner and thoroughly rinse with water. Dry off and reinstall. See paragraph 11.8 for instructions to remove the Dry Pak. As an alternative to removing and cleaning the block, call the factory for field adjustment procedures to increase purge settings.

12.10 LOW SYSTEM PRESSURE SHUTDOWN ALARM

12.10.1 The low system pressure shutdown alarm will occur should the system pressure fall below 15 psi. During a start-up sequence, there is a 45 second delay before shutdown occurs, otherwise 10 seconds of delay while in RUNNING condition. The LCD will display a MAJOR alarm condition (solid Red LED) with posted time and date of the occurrences.

12.10.2 A major air leak, such as from failure to restore a hose after some maintenance procedure, can cause Low System Pressure Shut down. Small leaks, even if numerous, would not be the cause of Low System Pressure Shutdown.

12.10.3 If either Purge Valve (7) is worn and sticks in the open position, Low System Shutdown will occur when the opposite Purge Valve is opened by the cycle timing that is controlled by the sensor board. Install repair kits (see Fig. 9) to both purge valves.

12.10.4 Having performed the procedures outlined above, should the Low System Pressure Shutdown alarm remain active, connect a test gauge to the test valve in the fitting at the top of the Water Sight Tube (24), to verify the actual System Pressure. If the test gauge verifies normal System Pressure, check the red supply tube which is routed from the Water Separator Tank (35) to the System Pressure Sensor for a crimp or an obstruction.

12.11 HIGH SYSTEM PRESSURE SHUTDOWN ALARM

12.11.1 The High System Pressure alarm will occur should the system pressure rise above 40 psi. The LCD will display a MAJOR alarm condition (Solid Red LED) with posted time and date of the occurrence.

12.11.2 A mis-adjustment of the system pressure and purge valve not opening may cause the pressure to go above 40 psi. Readjust the system pressure regulator and verify the purge valve cycle. A major blockage or crimped hose leaving the water separator tank and entering the Dryer Tower inlet is another possibility. Verify and correct as required.

12.11.3 Should the High System Pressure remain active, connect a pressure test gauge to the test valve in the fitting on top of the water sight tube (24) and verify the actual system pressure. If the reading is off, the system pressure sensor on the sensor board could be damaged or a problem exists with the circuit board. Replace the sensor board.

12.12 LOW LINE PRESSURE ALARM

12.12.1 Low Line Pressure Alarm will occur should the LINE pressure fall below its set pressure. The LCD will display a MINOR alarm condition (blinking Green/Red LED) with posted time and date of the occurrence. Should the condition clear on its own, the MINOR Alarm will automatically reset.

12.12.2 Low Line Pressure Alarm can be the result of maladjusted or defective Line Pressure Alarm Sensor, or simply an incorrectly adjusted Line Pressure Regulator (29). Check the adjustments of the alarm points (paragraph 8.3). Verify the accuracy of the Line Pressure by connecting a test gauge to the Test Valve on the Line Pressure Regulator. If the dehydrator output air flow, shown on the display is very close to maximum, it may be impossible to increase the Line Pressure and alarms may come and go because of changes in flow created by day/night temperature swings, or because of cable repair work.

12.13 HIGH LINE PRESSURE ALARM

12.13.1 The High Line Pressure alarm will occur should the line pressure rise above its set pressure. The LCD will display a MINOR alarm condition (Blinking Green/Red LED) with posted time and date of the occurrence. Should the condition clear on its own, the MINOR Alarm will automatically reset.

12.13.2 High Line Pressure Alarm is generally caused by the same conditions discussed in Paragraph 12.12, except that high outlet flow can not be the cause. A failure of the Line Pressure Regulator (29) can be the cause and would show up when making Alarm Point adjustments per paragraph 8.4.

12.14 ATS STANDBY SHUTDOWN

12.14.1 A.T.S. Standby Shutdown is normal indication that the dehydrator is placed in Standby Mode by an ATS300 Controller. When an ATS300 Controller causes the “Standby” to be displayed, all dryer alarms are disarmed while in standby mode. NOTE: During a start-up from a standby condition, most alarm sensor remain disarmed up to 3 minutes. The Humidity Bypass Valve will remain active regardless of the Disarm signal to the Humidity sensor. Only the Humidity Alarm output is disarmed.

13.0 BACKUP BYPASS OPERATION

13.1 The SmartTech Air Dryers can operate without the Display Module or Alarm/ATS Interface Module should a problem develop with either. Only a pressure test gauge is required to verify or make adjustments to the System Pressure and Line Pressure.

13.2 The Sensor Board is still required for controlling and operating many of the SmartTechs functions.

13.3 To run in Backup bypass mode, first turn OFF the Air dryer. Locate the J6 Connector on the Sensor.

13.4 Locate the Backup J6 Connector in the wiring harness (the cable has a wire marker “B” on it) and connect it to the Sensor Board.

13.5 Remove the CO#1 and CO#2 Alarm connectors from the Alarm/ATS Interface Module and reposition them on the CO backup connections located directly above. Also remove J6 and J5 off the alarm / ATS interface board.

13.6 Restart the SmartTech Dryer and verify the System Pressure and Line Pressure settings. Allow for a warm-up period and recheck settings before making any final adjustments. NOTE: Prior to restarting, the Display and Alarm/ATS Interface Modules may be removed.

Parts List for 22000ST and 33000ST Models

ITEM	PART NUMBER	DESCRIPTION	QUANTITY
1	100633	Cabinet side panel (replacement)	1
2	100632	Cabinet front door (replacement)	1
3	99045	LCD display board	1
4	100529	Sensor control board (programmed)	1
5	100530	Alarm/ATS interface board (programmed)	1
	64904	Backup Battery 3V	2
	0005385013	1-1/2 Amp Fuse Fast Acting	4
6	97901	Power ON/OFF switch	1
7	0043512001	Purge valve (complete valve assembly)	2
	0024815016	Purge valve kit	*
	0019525010	208V Purge valve coil only (low voltage coil)	*
	0019525008	240V Purge valve coil only (standard coil)	*
8	36785	Water eject solenoid valve	1
9	36785	Humidity shut-off solenoid valve	1
10	40342	Compressor circuit breaker (22000ST)	2
	40343	Compressor circuit breaker (33000ST)	2
11	105282	Fan/motor capacitor (capacitor only)	1
12	105260	Fan/motor assembly	1
13	40675	Transformer 208/240 - 115-24	1
14	103634	Compressor electrical contactor	2
15	0005354006	1/2 Amp Fuse Slo-Blo	2
15A	105096	Fuse holder	5
16	0005354019	3 Amp Fuse Slo-Blo	3
17	97919	High temperature sensor assembly	1
18	0018127001	Manual water eject switch	1
19	45348	High water shutdown switch	1
20	45347	Water eject plus low shutdown switch	1
21	36491	Water sight tube end cap	2
22	0014000221	Sight tube end cap o-ring	2
23	39993	Water sight tube (clear tube only)	1
24	41806	Complete sight tube assembly	1
25	32679A	DC-12 ST Compressor (22000ST)	2
	32098A	DC-20 ST Compressor (33000ST)	2
26	97877	Vertical quick disconnect manifold	2
27	97689	Quick disconnect manifold gasket	2
28	104284	System regulator	1
29	40437	Line pressure regulator	1
30	36550	Intake filter cover	1
31	36565	Intake air filter element	1
32	41932	Passive air intake	1
33	0046733005	Water fill fitting	1
34	0014000118	O-ring	1
35	99971	Water separator tank	1
36	0017495001	Air test valve	2
37	41790	System flow valve	1

Parts List for 22000ST and 33000ST Models (continued)

ITEM	PART NUMBER	DESCRIPTION	QUANTITY
38	101215	Heatless dryer assembly (22000ST)	1
	101216	Heatless dryer assembly (33000ST)	1
39	46221	Water filter housing	1
40	46222	Water filter element	1
41	0014000237	Water filter housing o-ring	1
42	10338	Water separator drain petcock	1
43	105281	Metering nozzle (22000ST) Yellow	2
	105280	Metering nozzle (33000ST) Red	2
44	105065	System controller (22000ST/33000ST)	
45	0022646003	Bypass air muffler	1
46	0040151001	Cabinet air filter	2
47	102657	Water to air heat exchanger	1
48	41125	3/4" Check valve (provided)	1
49	47744	Back flow check valve (provided)	1

Miscellaneous Items:

50	14490	3/8" Nylon tubing (specify inches)
51	0028722001	Hose clamp for 3/8" hose
52	14491	1/2" Nylon tubing (specify inches)
53	0002187001	Hose clamp for 1/2" hose
54	14492	3/4" Nylon tubing (specify inches)
55	0002187003	Hose clamp for 3/4" hose
56	14493	1" nylon tubing (specify inches)
57	0002187005	Hose clamp for 1" hose
58	41121	1/4" tube, black (specify inches)
59	41122	1/4" tube, red (specify inches)
60	41123	1/4" tube, green (specify inches)
61	41124	1/4" tube, blue (specify inches)
62	37117	3/4" pipe thread to 3/4" hose barb fitting
63	37391	1" Nylon Steel Wire reinforced tubing
64	62760	Water filter bowl wrench



Figure 3, Front View

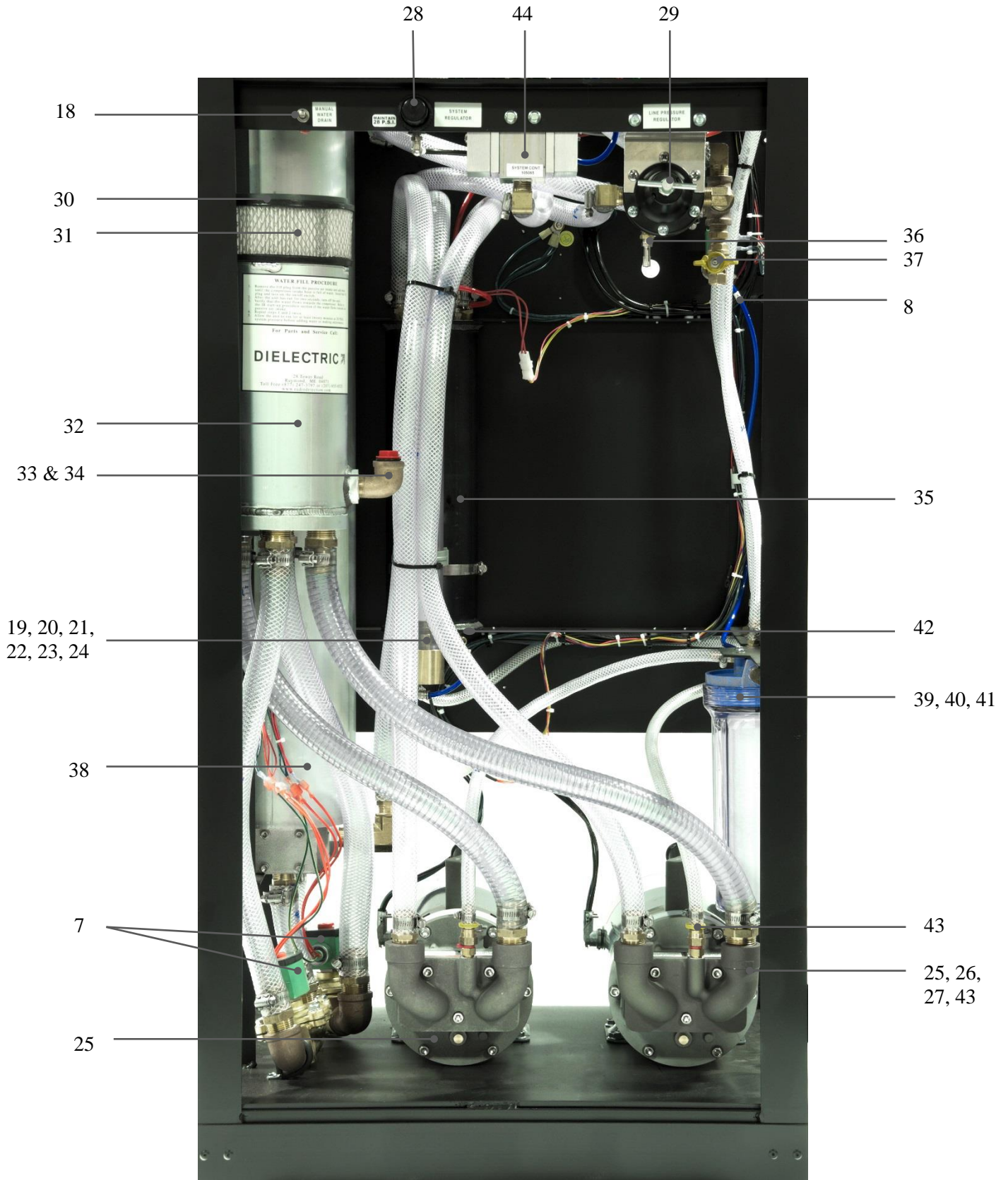

Figure 4, Side View, Cabinet Open



Figure 5, Electrical Enclosure

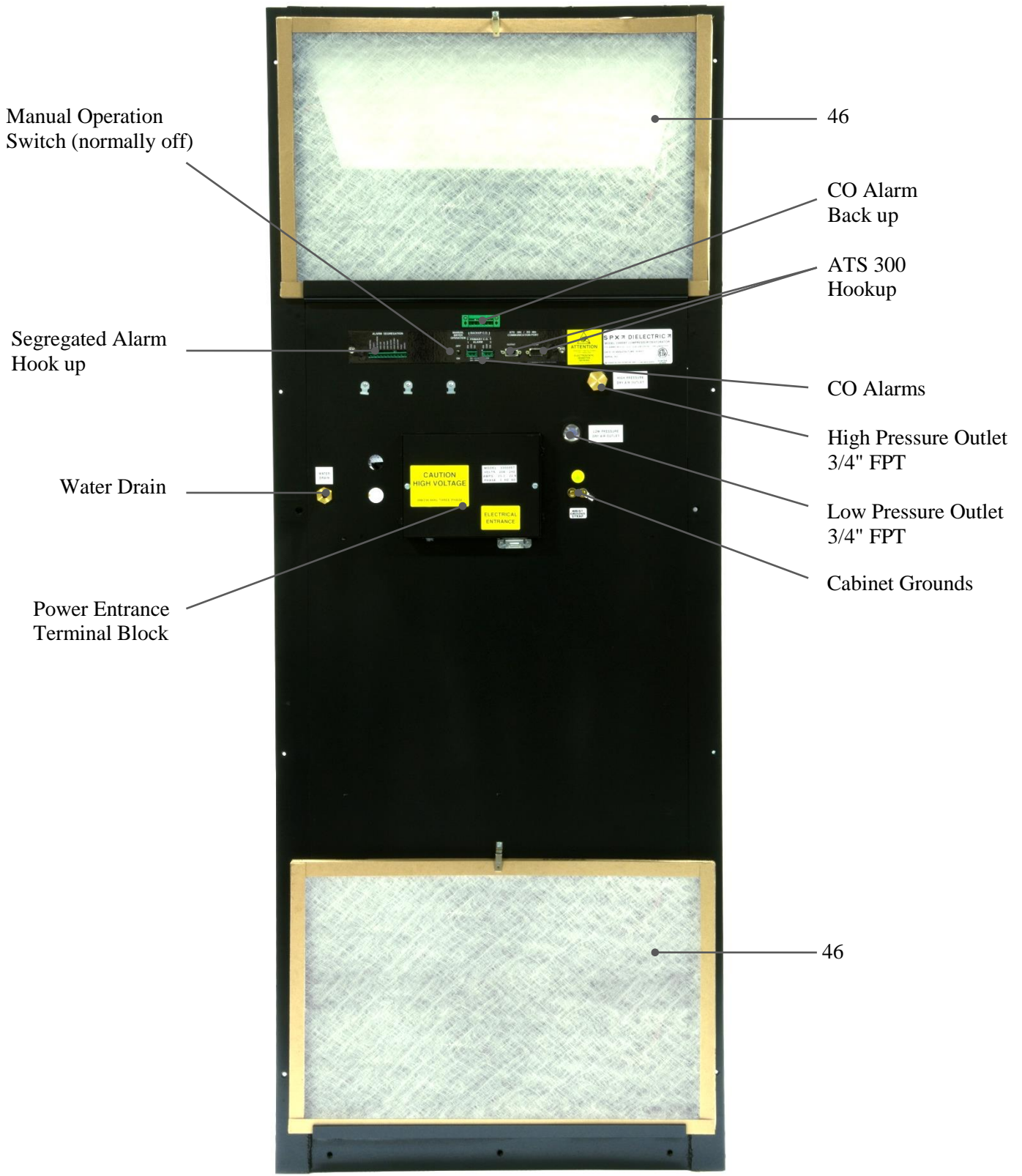

Figure 7, Rear View

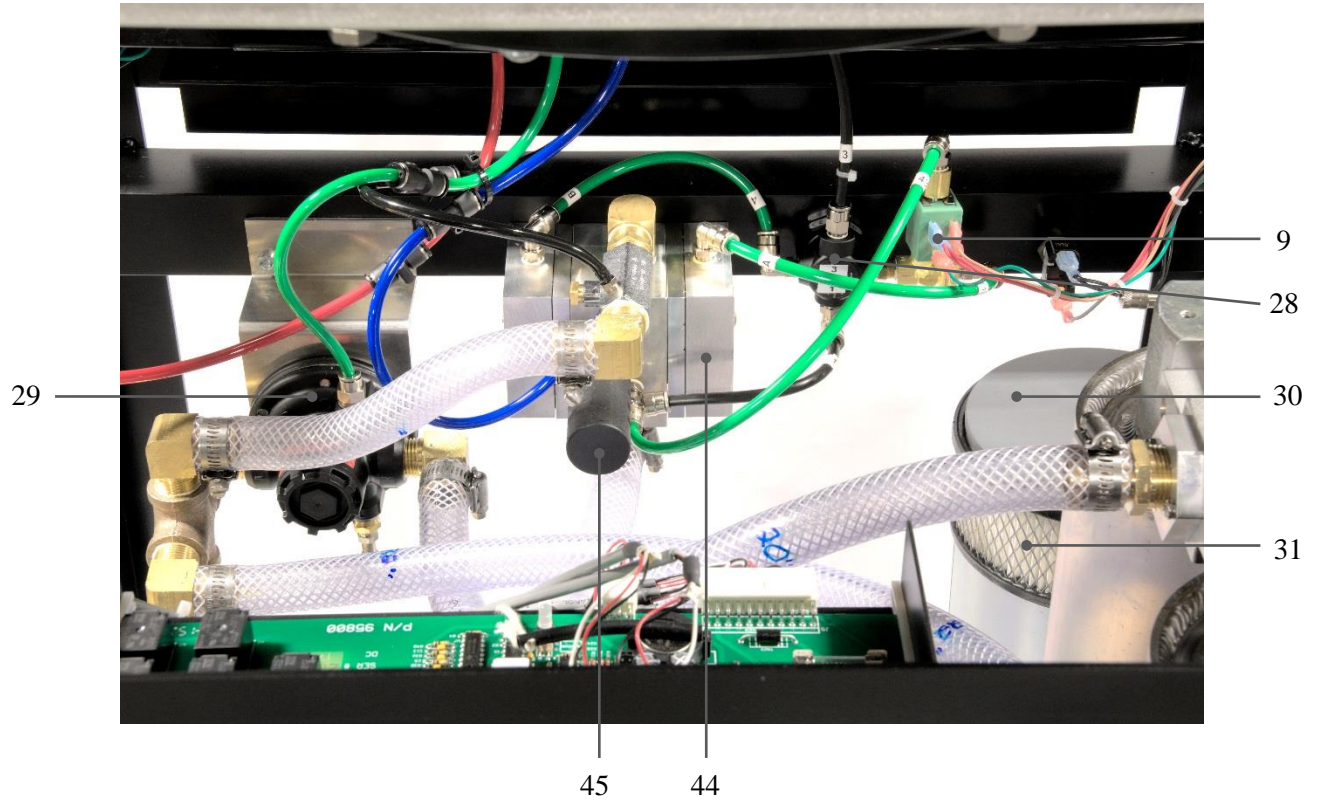

Figure 8, Inside View

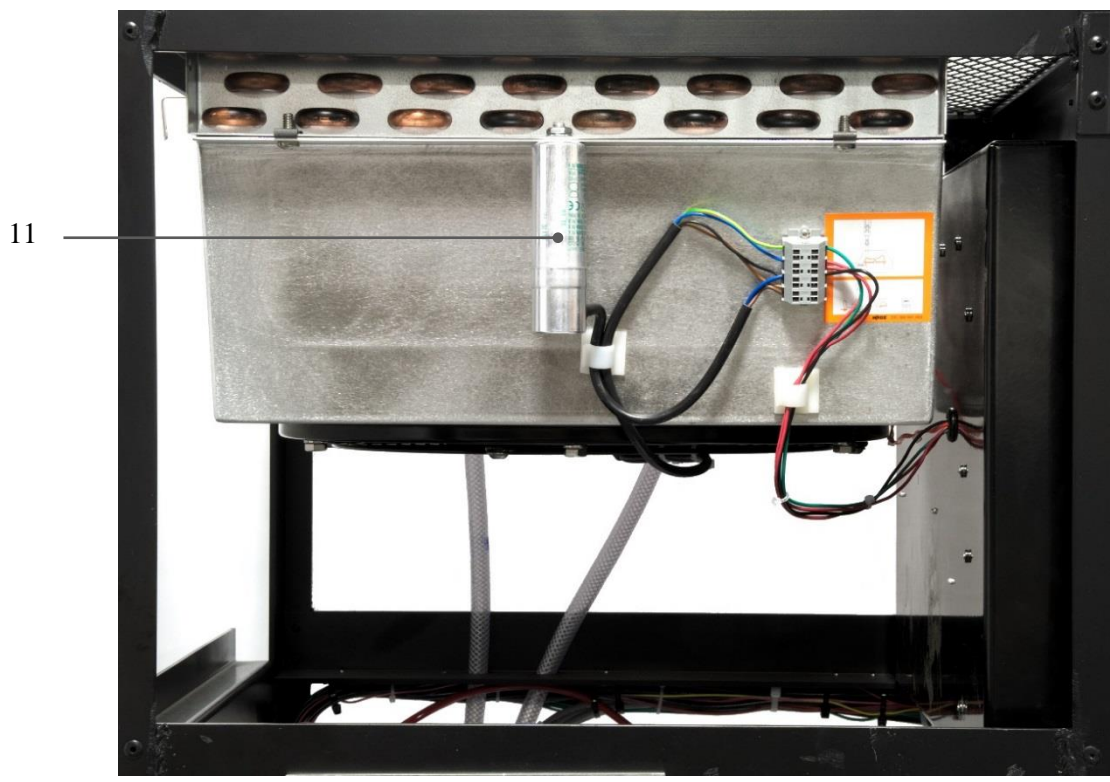
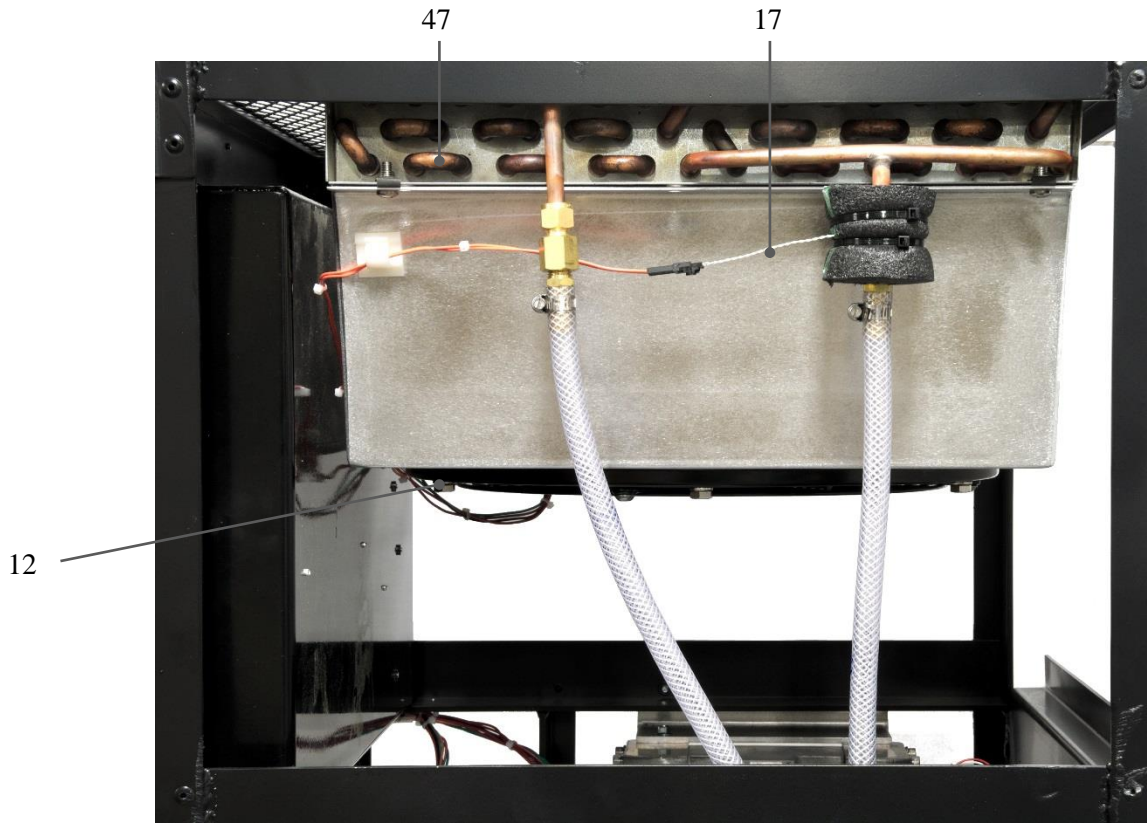
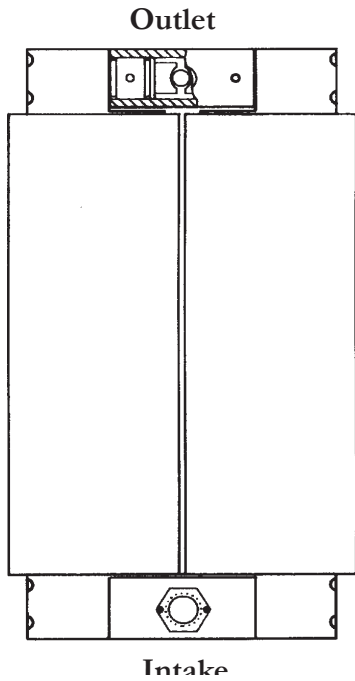
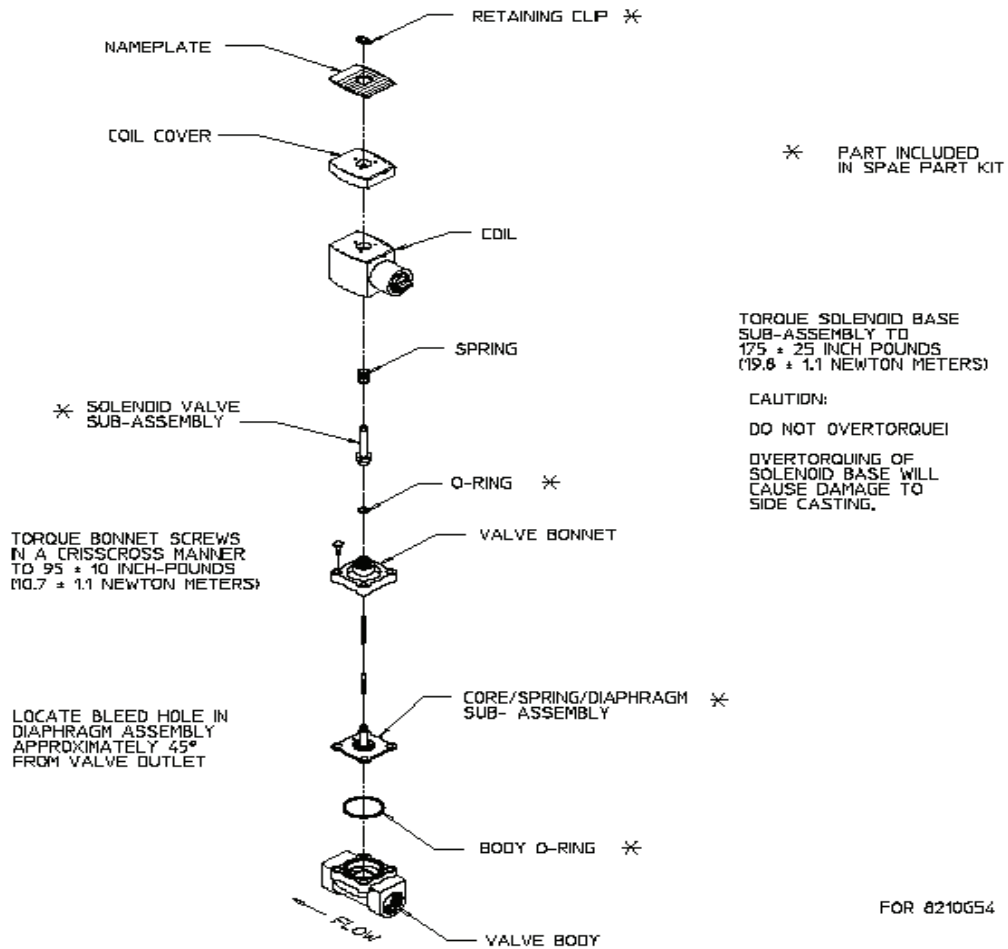

Figure 9, Heat Exchanger/Fan Compartment



Replacement Parts For Heatless Dryer	
Spare Upper Center Block (22000ST)	P/N 100639
Spare Upper Center Block (33000ST)	P/N 100638
Spare Lower Center Block	P/N 53070
Check Ball	P/N 15903-008

Figure 10, Heatless Dryer (typical)



APPENDIX A (Alarm Connection Wiring)

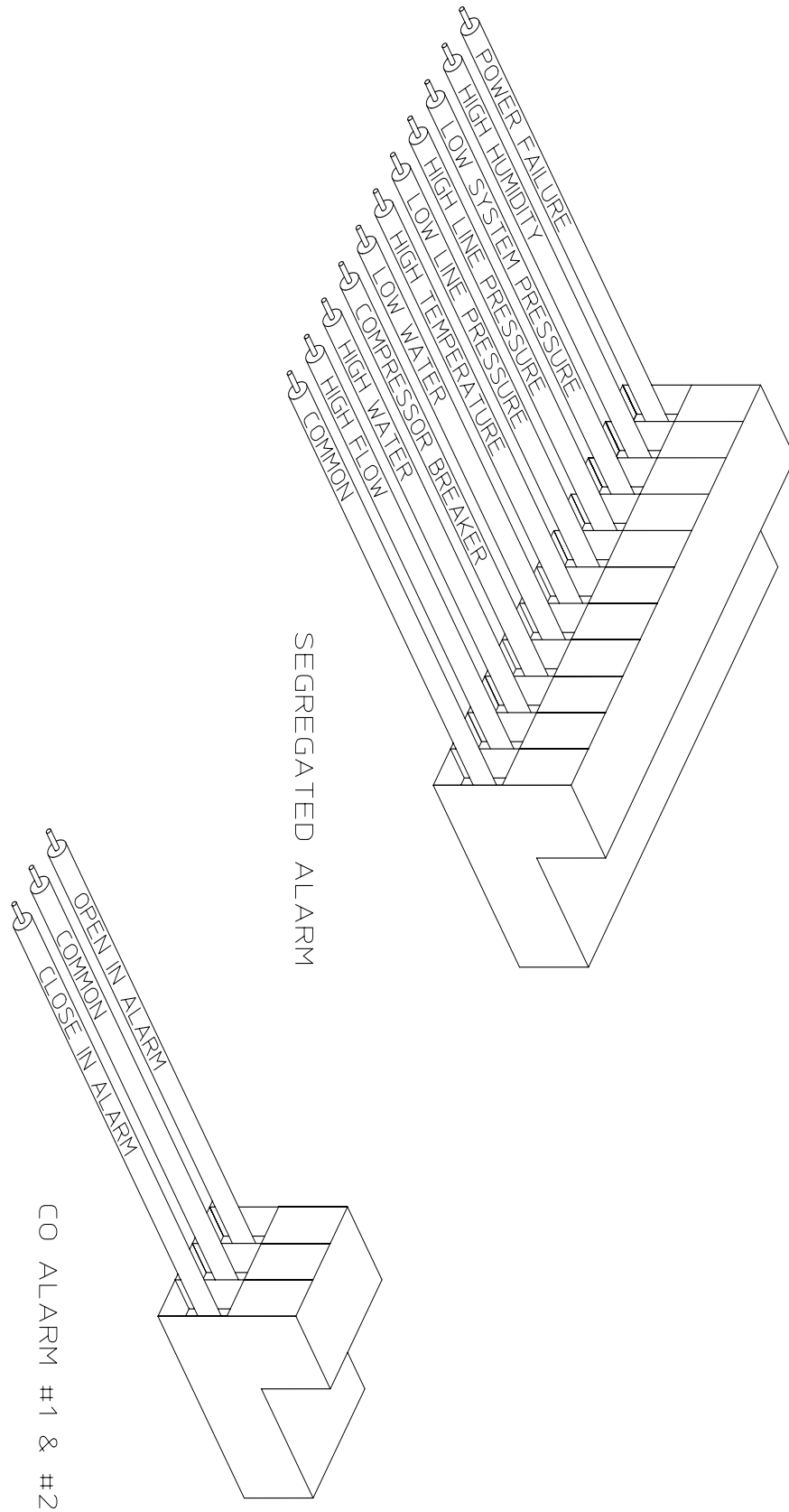

APPENDIX A (Alarm/ATS Interface Board)

ALARM / ATS INTERFACE BOARD

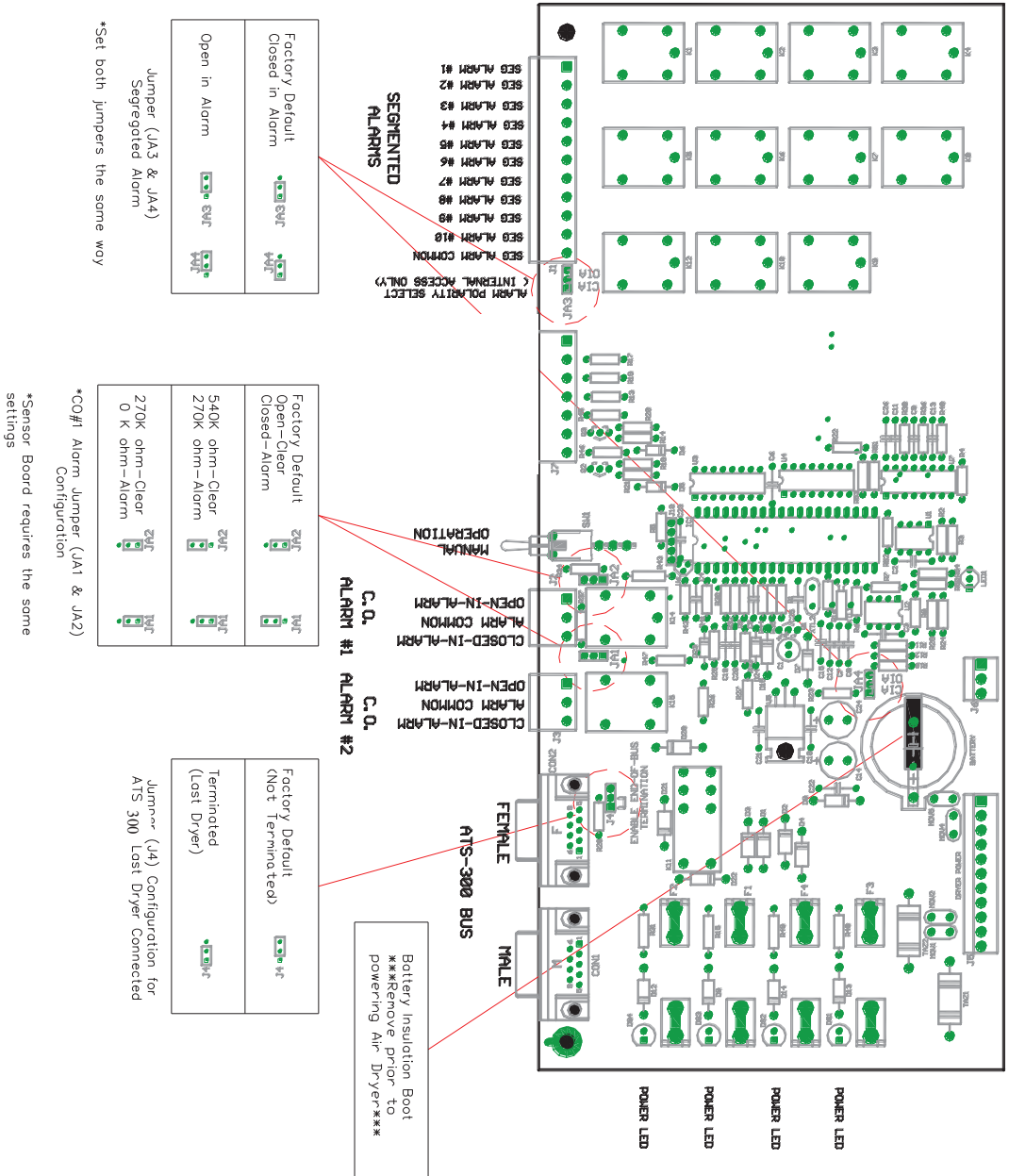

APPENDIX A (Sensor Board)

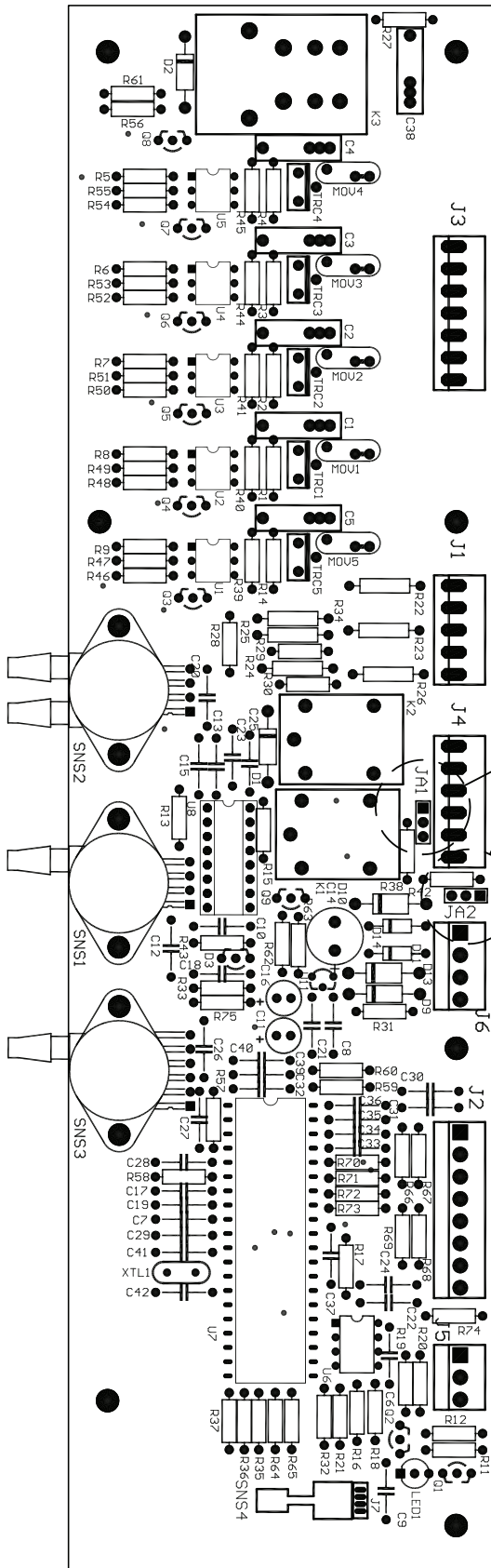

Factory Default		
Open-Clear	JA1	JA2
Closed - Alarm		
540K ohm-Clear	JA1	JA2
270K ohm-Clear	JA1	JA2
0 ohm-Clear	JA1	JA2

CO 1 JA1 & JA2 Alarm Jumper Configuration
 * ALARM / ATS INTERFACE BOARD must have the same settings as the Sensor Board.

SENSOR BOARD
 Backup CO#1 Configuration

APPENDIX C (Front Panel Display Features)

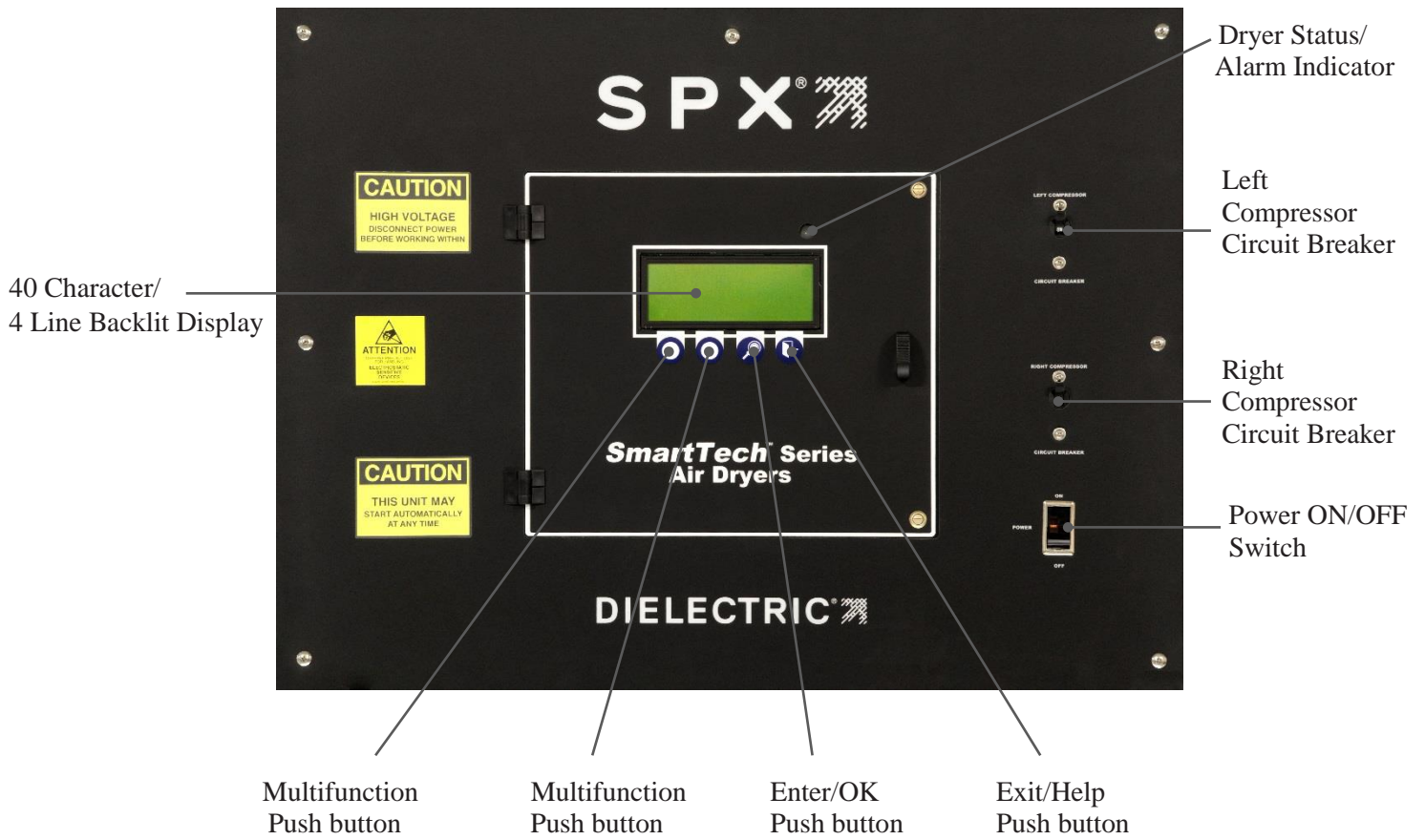

APPENDIX C (SmartTech Menu Block Diagram)

SmartTech Menu Block Diagram

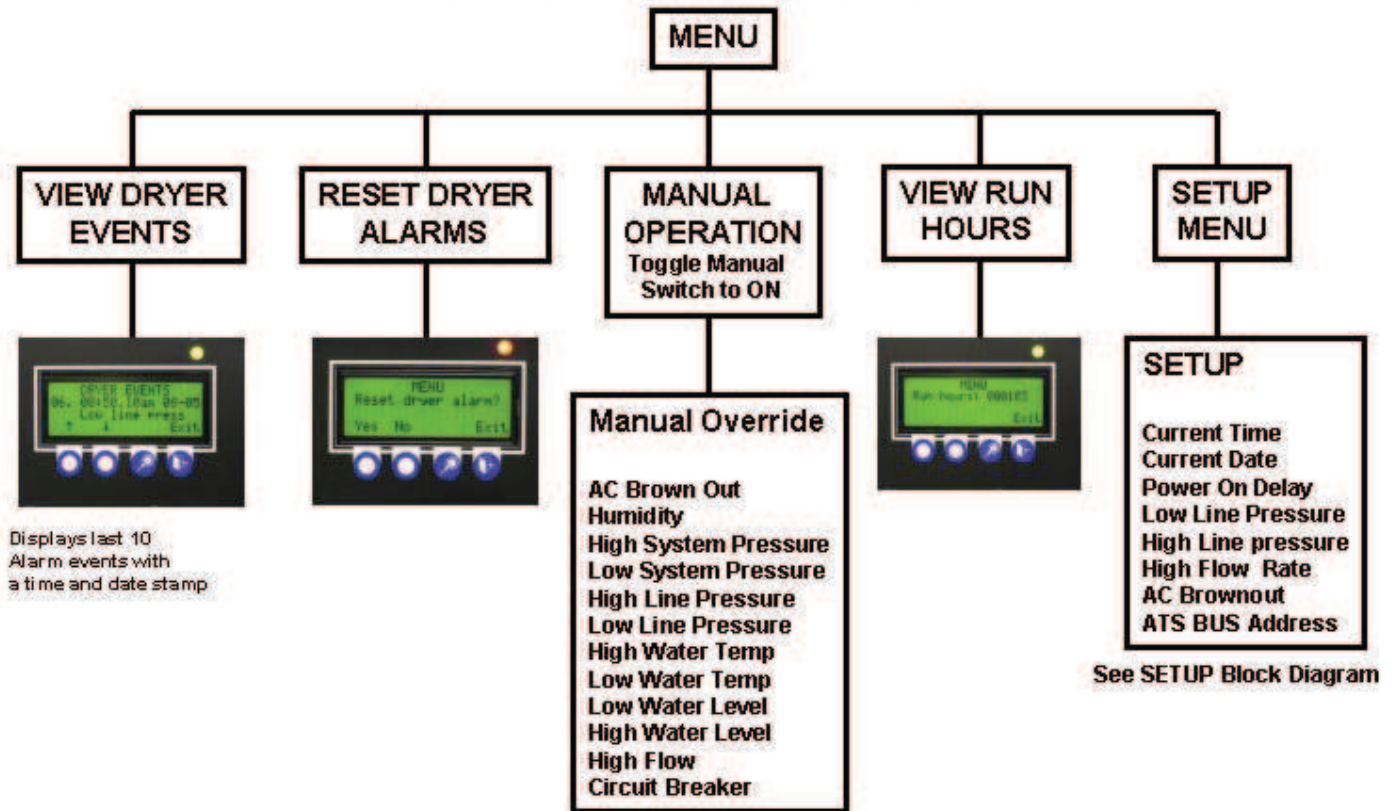

Displays last 10 Alarm events with a time and date stamp

Toggle Manual Operation Switch to ON . AC Brown is a automatic default. Select and Toggle other sensors On or Off. Press **OK to Enter Manual Mode**

See SETUP Block Diagram

APPENDIX C (Setup Menu Block Diagram)

Setup Menu Block Diagram

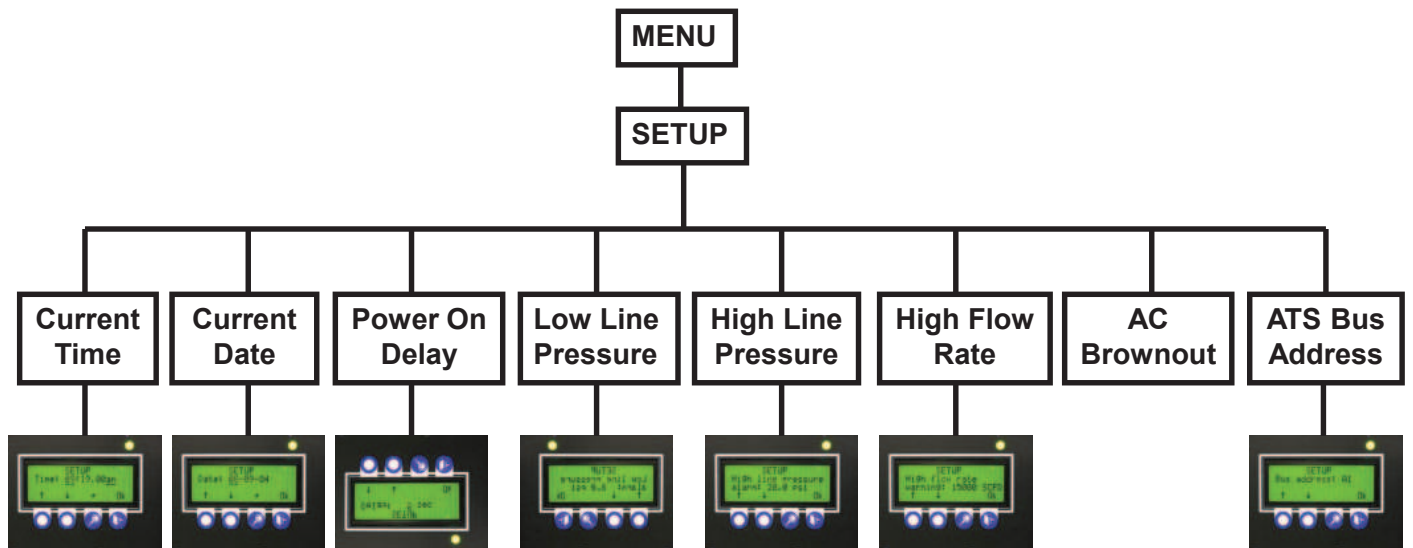

Selection of
A1-A8, B1-B8,
C1-C8, D1-D8,
and E1-E8

APPENDIX D (Wiring Electrical Schematic)

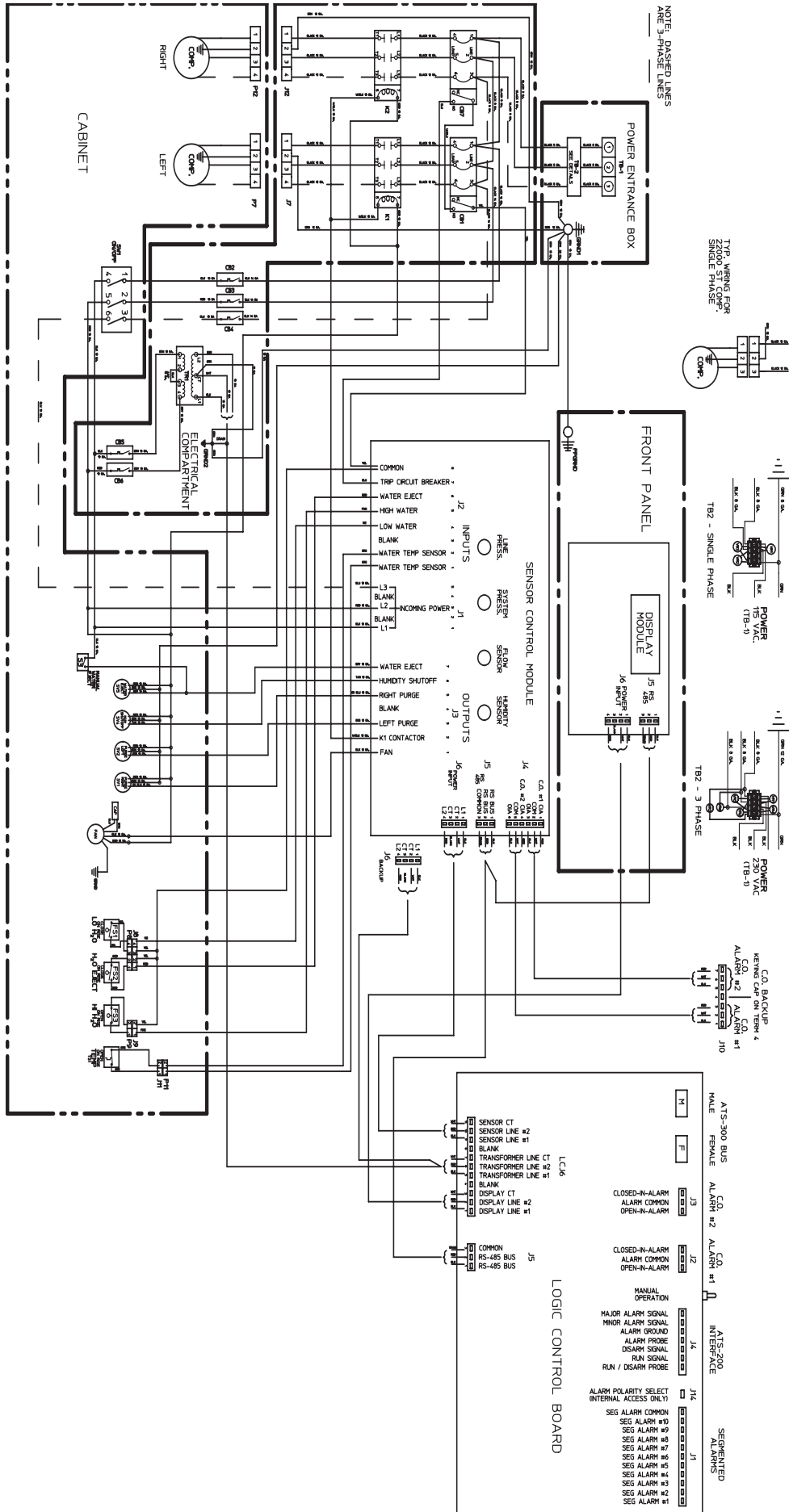

APPENDIX E (SmartTech Fusing and Circuit Protection)

SmartTech FUSING AND CIRCUIT PROTECTION

DESIGNATION	DESCRIPTION	FUSING	PROTECTION
CB1	Compressor Breaker	20amp ON/OFF	Watersealed Compressor
CB7	Compressor Breaker	20amp ON/OFF	Watersealed Compressor
CB2(Fuse)	AC Controls (L1)	3amp Slo-Blo	Fan, Purge Valves, Water
CB3(Fuse)	AC Controls (L2)	3amp Slo-Blo	Eject Solenoid, Bypass
CB4(Fuse)	AC Controls (L3)	3amp Slo-Blo	Solenoid, Contactor Coil
CB5(Fuse)	Transformer In	1/2amp Slo-Blo	Power Supply to Display,
CB6(Fuse)	Transformer In	1/2amp Slo-Blo	Sensor and Alarm/ATS PCB
ATS/Alarm Circuit Board			
F1	ATS Comm	1.5amp fast acting	ATS Bus Transformer and
F2	ATS Comm	1.5amp fast acting	backup power to Display
F3	Power Supply	1.5amp fast acting	Display, Sensor, ATS/Alarm
F4	Power Supply	1.5amp fast acting	PC Boards
VR1-VR6	Varistor	P250LA40	Surge Protection on Incoming AC Lines

NOTE:

1. 1.5 amp fuse is a ¼ x 1-1/4 “ fast acting type 3AG or equivalent. Dielectric P/N 0005385013
2. The LEDs adjacent to F1, F2, F3, and F4 indicate that the fuse is good and not blown. If not ON, first check for CB5 and CB6 not tripped.
3. For Surge Protection Varistors P250LA40 P/N 0043182005 are used on Incoming AC Terminal Board

APPENDIX F (SmartTech Alarms)

Alarm Classifications

Major Alarms are those alarms that will cause the Air Dryer to Shut Down and become registered at the CO Terminal Block. These alarms are Low and High System Pressure, Low and High Water level, Low and High Water Temperature, Circuit Breaker, Power Loss and Humidity (Minor first then Major after the 5 minute shutdown delay)

Minor Alarms are those alarms that will allow uninterrupted Dryer operation and become registered at the CO Terminal Block. These alarms are Low and High Output Line Pressure.

SmartTech Air Dryer Alarms

A Low System Pressure Major Alarm occurs when the system pressure drops below 15 psig . Upon Start-up, there is a 45 Second disarm period. After the start-up disarm period, there is a 10 second Time Lag before the alarm becomes registered at the CO and Segregated Terminal Blocks with no Delay on Shutdown.

A High System Pressure Major Alarm occurs when the system pressure rises above 40 psig . Upon Start-up, there is a no disarm period. There is a 10 second Time Lag before the alarm becomes registered at the CO terminal blocks with no Delay on Shutdown.

A Humidity Major Alarm occurs when the %Relative Humidity of the outlet air rises above 5%RH. . Upon Start-up, there is a 180 Second disarm period., After the start-up disarm period, there is a 5 second Time Lag before the alarm becomes registered at the CO and Segregated Terminal Blocks with 5 minutes Delay on Shutdown. Note, there are no delays or disarming for the Humidity Bypassing control circuit.

A Low Water Major Alarm occurs when the Low Water Float drops below its corresponding switch. Upon Start-up, there is a 15 Second disarm period. After the start-up disarm period, there is a 5 second Time Lag before the alarm becomes registered at the CO and Segregated Terminal Blocks with no Delay on Shutdown.

A High Water Major Alarm occurs when the High Water Float rises above its corresponding switch. Upon Start-up, there is no disarm period. There is a 5 second Time Lag before the alarm becomes registered at the CO and Segregated Terminal Blocks with no Delay on Shutdown.

A Low Line Pressure Minor Alarm occurs when the line pressure drops below the factory default setting of 8 psig . Upon Start-up, there is a 180 Second disarm period. After the start-up disarm period, there is a 5 second Time Lag before the alarm becomes registered at the CO and Segregated Terminal Blocks. Alarm resetting is automatic upon clearing.

A High Line Pressure Minor Alarm occurs when the line pressure rises above the factory default setting of 20 psig . Upon Start-up, there is a no disarm period. There is a 5 second Time Lag before the alarm becomes registered at the CO and Segregated Terminal Blocks. Alarm resetting is automatic upon clearing.

A Power Loss Major Alarm occurs when the voltage drops below the Brown-Out level for any phase. The factory setting is 180Volts. Upon Start-up, there is a no disarm period. There is no Time Lag before the alarm becomes registered at the CO and Segregated Terminal Blocks. Alarm resetting is automatic and upon clearing the dryer will enter a standby mode, and will delay for the “power-on delay” setting before starting the dryer.

A High Temperature Major Alarm occurs when the Water temperature leaving the heat exchange rises above 160 degrees F. Upon Start-up, there is no disarm period. There is a 1 second Time Lag before the alarm becomes registered at the CO and Segregated Terminal Blocks with no Delay on Shutdown.

A Brownout Fault Major Alarm occurs after 3 concurrent attempts to automatically restart the Air Dryer. This is a Major Alarm and becomes registered at the Central Office and segregated terminals as power failure.

A Low Temperature Major Alarm occurs when the Water temperature leaving the heat exchange drops below 35 degrees F. Upon Start-up, there is no disarm period. There is a 1 second Time Lag before the alarm becomes registered at the CO terminal Blocks with no Delay on Shutdown. The Low Temperature Alarm is not disarmed by an ATS300, such that SmartTech dryers held as a Standby dryer in an ATS300 installation will be placed into a Major Alarm state when a Low Temperature condition occurs.

A Compressor Breaker Major Alarm occurs upon the tripping of this breaker . Upon Start-up, there is no disarm period. There is a 1 second Time Lag before the alarm becomes registered at the CO and Segregated Terminal Blocks with no Delay on Shutdown.

A High Flow Warning occurs when the Air Flow exceeds the capacity of the Air Dryer. The Factory default varies based on Model. Upon Start-up, there is no disarm period. There is a 30 second Time Lag before the warning becomes displayed. There is no registration at the CO terminal blocks but is registered on the Segregated Terminal Blocks #10th position. There is no Delay on Shutdown and the warning is self-clearing.

APPENDIX G (Power Termination and Grounding)

PROPER MULTIPLE GROUND ON SINGLE SCREW

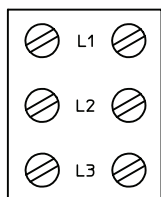
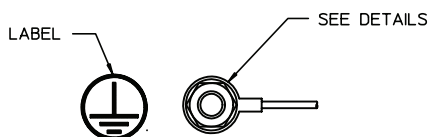

TB1
INCOMING POWER
TERMINAL BOARD

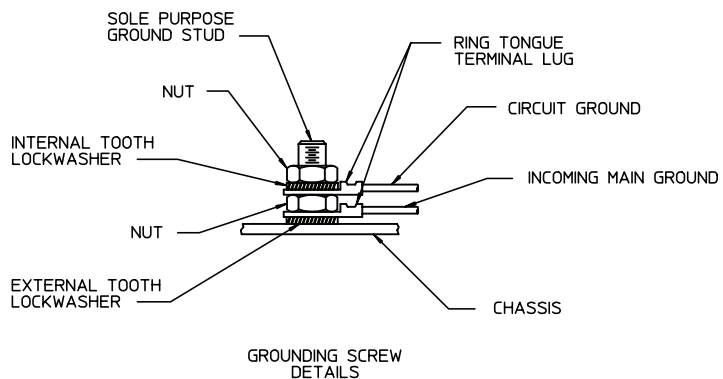

CIRCUIT GROUND CAN BE REMOVED
FOR SERVICING INDEPENDENTLY OF
INCOMING GROUND.

APPENDIX H

GLOSSARY of TERMS as used throughout this manual.

Ambient: The environment surrounding the dehydrator. Ambient factors which can influence a dehydrator include the temperature, the relative humidity, the atmospheric pressure and quantity of various pollutants which are present.

Desiccant: The component within the dryer towers which is used alternately to retain, then to expel moisture from the process air. Dielectric dryers employ desiccant which is totally inert, that is; it undergoes no chemical or physical change in normal use.

Dew Point: Expressed in °F, the temperature at which dew or frost would form at 14.7 PSIA. The dew point of a given air sample rises with increased pressure. In 1943 Dielectric established a dew point of -40°F. as standard for their compressor/ dehydrators and for the pressurization of the communications equipment which they produce. NOTE: -40° is the one point at which the Fahrenheit and Celsius scales are numerically equal.

Heatless Dryer: A dryer design of Dielectric which describes the most simple and efficient heatless air dryer. A dryer consists of two desiccant towers, two maintenance free ball checks and two direct acting solenoid valves controlled by a solid state timer. The main air flow is handled by the ball checks without measurable pressure loss. Only the purge air flows through the two way solenoid valves, providing high efficiency and long trouble free service.

Elevation: The distance which the installation site is above sea level expressed in feet, used interchangeably with altitude.

Line Pressure: The pressure of the low pressure outlet system, which is controlled by adjustment of the line pressure regulator, is displayed on the line pressure gauge and is monitored by the adjustable low and high pressure alarm switches.

Prime: To prepare the dehydrator system for operation by filling it with water, to the proper level and in a specified manner.

PSIA: Pounds per Square Inch Absolute. The measure of the pressure of a gas or liquid, expressed in pounds per square inch, relative to a total vacuum. Standard atmosphere at sea level equals 14.7 PSIA (approx.) or 0 PSIG.

PSIG: Pounds per Square Inch Gauge. The measure of the pressure of a gas or liquid within a component or system, to the degree it is greater than that of the surrounding atmosphere, expressed in pounds per square inch. The internal pressure as shown on the gauges used on air dryers.

SCFD: Standard Cubic Feet per Day. A rate of air flow measured in cubic feet at 14.7 PSIA and 68° F. One SCFD when subjected to 10 PSIG (without temperature change) would occupy a space equivalent to 0.6 cubic feet.

Segregated Alarm: An alarm circuit which provides separate terminations for each alarm function within the dehydrator. Segregated alarms can provide to a remote location the information necessary for establishment of maintenance priorities. Segregated alarm terminations which close in alarm are standard on the RE series dehydrators.

Std. conditions: Standard operating conditions imply a reasonably clean environment at 70°F.(21°C.) and sea level. Ambient conditions impact dryer maintenance needs.

Summary Alarm: An alarm which does not identify an individual condition, but which indicates an active state of one or more alarm sensors within the dehydrator. Alarm terminations which close in alarm and separate terminations which open in alarm are standard on the RE series dehydrators. The close-in-alarm terminals may optionally be equipped with resistors at installation if preferred.

System Pressure: The pressure at which the compressors and the drying towers (desiccant towers) operate. System Pressure determines the quantity of compressed air flow, the quantity of purge air and the moisture load on the desiccant towers.

WARRANTY

The Manufacturer warrants that all goods supplied hereunder, whether or not of its own manufacture, will be of the kind described herein or in any specification and drawing approved by the Manufacturer and free from defects in material or workmanship under normal use and prescribed maintenance for a period of one (1) year, with the exception of air dryers utilizing water sealed compressors as well as the compressors themselves which shall be for two (2) years. Neither this warranty nor any other, expressed or implied, shall apply to goods delivered hereunder which have been damaged or subjected to alteration or negligence after delivery. The Manufacturer's only obligation for breach of this warranty shall be the repair, without charge, or the furnishing EX Works Raymond Maine, of a similar part to replace any part which within one (1) year, with the exception as noted above, from date of shipment is proven to have been defective, provided that (i) the Purchaser shall have notified the Manufacturer within ten (10) days of the discovery of such defect and not later than ten (10) days after the last day of this warranty, and (ii) the Manufacturer shall have the option of requiring the return of the defective material (transportation prepaid) to establish the claim. The Manufacturer shall not in any event be liable for the Purchaser's manufacturing costs, loss of profits, good will or any other special, consequential, incidental, or other damages resulting from such defects. THERE ARE NO OTHER WARRANTIES, EXPRESSED OR IMPLIED, WHICH EXTEND BEYOND THE WARRANTY SET FORTH HEREIN.

Radiodetection (USA) 28 Tower Road, Raymond, Maine 04071, USA
Tel: +1 (207) 655 8525 Toll Free: +1 (877) 247 3797 Fax: +1 (207) 655 8535 rd.sales.us@spx.com www.radiodetection.com

Radiodetection Ltd. (UK) Western Drive, Bristol BS14 0AF, UK
Tel: +44 (0) 117 976 7776 Fax: +44 (0) 117 976 7775 rd.sales.uk@spx.com www.radiodetection.com

© 2017 Radiodetection Ltd. All rights reserved. Radiodetection is a subsidiary of SPX Corporation. Dielectric is a trademark of Radiodetection in the United States and/or other countries. Due to a policy of continued development, we reserve the right to alter or amend any published specification without notice. This document may not be copied, reproduced, transmitted, modified or used, in whole or in part, without the prior written consent of Radiodetection Ltd.