

DIELECTRIC® 

Model MGD-2002 Multi Gas Leak Detector

Instruction manual

IB-417 REV. I PART NO. 84671



SPX® 

User Safety Warnings

IMPORTANT: Before operating the device for the first time, read all of the following safety guidelines. To prevent personal injury, property damage, or damage to the detector, operate it only in accordance with these safety guidelines.

- Do not operate the device if it has been damaged. Contact SPX Radiodetection for advice.
- Do not allow any part of this device to come in contact with an energized high voltage source. Injury or death may result.
- Do not disassemble the device as it will void your warranty. Repairs should only be performed by qualified factory service personnel.
- Do not allow the Detector to draw up water. Water will adversely affect the device's operation and will cause internal damage. Water found inside the unit will void your warranty.
- Take sensible precautions to prevent the ingress of moisture when using the detector in rain, snow or other adverse conditions. Although the detector is somewhat water resistant, it is not waterproof. Do not allow water to accumulate on the detector faceplate, as it could migrate into the electronics.
- Do not use the probe tip to dig in the soil, or use it in any manner other than as directed in this manual.
- Although this device will operate with a low battery voltage, do not operate the detector when the battery indicator displays 1/4 battery or less. False readings may occur when operated under this condition. Refer to pages 7 through 9 for instructions on how to recharge or replace the battery.
- When charging: This unit should be in an indoor dry location.
- Do Not plug the battery in backwards. Circuit board damage will result



CAUTION - Refer to accompanying information

Table of Contents

Section	Description	Page
	User safety warnings	i
	Table of contents	ii
1.0	Specifications	1
2.0	List of kit contents	2
3.0	Unpacking your New MGD-2002	3
4.0	Tracer gas	4
	4.1 Helium vs Hydrogen as a tracer gas	
	4.2 Other Gasses the MGD-2002 will react too	
5.0	Assembling the MGD-2002 for use	5
6.0	Operation of the MGD-2002	6
	6.1 Overview	
	6.2 Humidity vs Accuracy	
	6.3 Moisture filter	
	6.4 Power supplies	
	6.5 Charging the battery	
	6.6 Charging the battery using the universal power supply	
	6.7 Charging the battery from a 12VDC auto adaptor	
	6.8 Replacing the battery	
	6.9 Button function and operation	
	6.10 Liquid crystal display (LCD)	
	6.11 Display status icon	
7.0	Tracer gas leak locating for piping systems	14
8.0	Leak locating for pressurized cables	21
9.0	Serial port (if equiped)	33
10.0	Maintenance	33
11.0	Calibration	35
12.0	Frequently asked questions (FAQ)	36
13.0	Troubleshooting	39
14.0	Service information	40
Warranty		Back cover

1.0 Specifications

Dimensions:	(LxWxD)	13.3in x 4.9in x 3.3in (33.7cm x 12.3cm x 8.3cm)
Weight:	(MGD-2002 only) (Shipping)	3.1 lbs (1400 grams) 15.0 lbs (6800 grams)
Temperature Range:		+40°F to +110°F (+4°C to +43°C)
Humidity Range:		20% RH to 50% RH
Sensitivity:	(Min) (Max) (Increment)	25 PPM 100% (1,000,000 PPM) 25 PPM (0 to 20,000 PPM) 0.1% (2% to 100%)
Tracer gasses:		Helium (He) / Hydrogen (H)
Resolution:	(Low range) (High Range)	+/- 25 PPM +/- 0.2 %
Response Time:		15 Seconds (approx.)
Audio Out:		Pulse Width Modulation
LCD:		128 Bit X 64 Bit Dot Matrix with long-life backlight
Battery:	(Voltage) (Type) (Weight) (Run Time) (Charging Cycles) (Charging Volts)	7.2 VDC Nickel Metal Hydride 383 grams 6-8 Hours Continuous 300 - 500 9.5 - 14 VDC @ 2A
Power Supply:	(AC Input) (Charger) (DC Output)	110-240V, 1.6A, 60/50Hz 12V, 4.0A
Pump Volume:		1.05 Liters/Min (approx.) 0.85 to 1.00 L/min 0.75 to 0.85 L/min 0.60 to 0.70 L/min
Compliance		CE



2.0 List of kit contents

Description	Part No.
1. MGD-2002 gas detector	79766
2. 12VDC Auto Adaptor charger	163-0005-01
3. Ground probe with Collection cup	90664
4. Spare moisture filter cartridge	83220
5. Sampling handle	83174
6. Needle probe	84165
7. Battery NiMH	82492
8. Sholder strap	300-0012-00
9. Backflush connector	84972
10. 110-240 VAC universal AC charger	93642A
11. Carry case	84672

Optional equipment not included

- Headphones 882-0007
- European power cord 241-0003-00
- Serial port requires factory installation

3.0 Unpacking your New MGD-2002.

3.1 Upon delivery

- 1) Open the shipping package and inspect the MGD-2002 for any physical damage that may have been caused during shipping. Keep the packing material in case you ever need to return the device to SPX Radiodetection.

NOTE: The Manufacturer's warranty does not cover damage caused in transit. You must notify your carrier immediately for any damage claims.

- 2) Position the device face down to open the battery compartment door. Remove the battery to expose the device information placard. (The serial number is located under the barcode.)
- 3) Connect the battery plug to the main logic board. Close the battery compartment door and secure with the quarter turn fastener.

NOTE: Connecting the battery incorrectly even for a second will destroy the circuit board.

- 4) First, plug the universal power supply into a convenient AC wall outlet then plug the other end into the device.

NOTE: To ensure optimum battery working life, charge battery for 2 hours before operating the MGD-2002 detector for the first time. See page 7 for battery charging instructions.

- 5) Check the moisture cartridge filter and ensure it is blue in color. Refer to page 34 for filter changing instructions.
- 6) Before switching the device on, connect either the needle probe or ground probe to the handle assembly and then connect the handle assembly to the detector using the quick connect fitting on the end of the black tubing. Refer to page 5.

4.0 Tracer Gas

4.1 Helium vs. Hydrogen as a tracer gas

The MGD-2002 is a Helium/Hydrogen detector calibrated to detect “Helium”. However, it will indeed give readings if hydrogen is present. As this detector is based on the thermal conductivity of gasses and with Helium and Hydrogen being similar in this regard the detector will not be able to tell the difference.

Helium is the preferred tracer gas. Helium is a noble gas and does not react or combine with any other gas or substance. It is safe to use in all types of leak locating at any concentration up to 100%.

Hydrogen is not generally present in higher quantities in uncontrolled situations as it is very reactive and if in quantities greater than 4% *it is very flammable and even explosive*. To use it as a tracer gas you need to purchase it mixed to 4% or less with the remainder being nitrogen. Thus, starting with an already diluted tracer gas making it that much harder to find as it dilutes even further when you add it to the system being tested. (not a problem when working with 100% helium) We certainly DO NOT recommend Hydrogen be used as a tracer gas for these reasons.

Note: It would take more than 20 tanks of 4% hydrogen mix to equal the amount of traceable gas in one 100% helium tank. Mixing the helium down to 4% is certainly an option and can be done by adding compressed air to the system as it is being filled.

4.2 Other Gases the MGD-2002 will react to

When considering all other gasses there are some that would normally present false reading when in high concentrations such as CO, CO₂ and Ozone (on a busy street) with helium detectors using this above mentioned sensor type. However, we looked at this situation based on our experience with older models of our detectors and through the development of some patented filter media combinations and custom software we have eliminated or captured these gasses eliminating the majority of false readings. Unfortunately methane even in very low concentrations can cause the MGD-2002 to react but this is generally only seen during certain environmental tests.

5.0 Assembling the MGD-2002 for use.

When assembling the device, refer to the List of Kit Contents on page 2 of this manual.

1. Clip the black sampling tube quick-release connector of the sampling handle (5) onto the connector on end of the MGD-2002 detector (1).
2. Attach either the needle probe (6) or the Ground probe (3):
 - To attach the needle probe snap it into the quick connect coupling of the sampling handle cap/adaptor.
 - To attach the ground probe: Unscrew the cap/adaptor from the sampling handle and screw the sampling handle into the extendable ground probe (3). Do not overtighten (Hand tight). *Note: applying a small amount of silicone based lubricant to the seal on both ends of the moisture cartridge will improve its performance.*
3. To extend the ground probe, press the lock button on the sample probe and with it pressed, gently pull on the sample collection cup. When the sample probe is at the required length, release the lock button, ensuring it engages in a locking position.
4. Turn the MGD-2002 on. The MGD-2002 will perform a self check and zeroing routine (1 min approx). You are now ready to look for Helium/Hydrogen



6.0 Operation of the MGD-2002

6.1 Overview

The MGD-2002 gas detector is a portable leak-locating and pinpointing device that can be used in a multitude of pressurized systems to detect both hydrogen and helium when used as a tracer gas . Because they are both lighter than air, hydrogen and helium penetrate small leakage points rapidly. The gasses permeate through the densest soils and pavements quickly enabling the leak to be pinpointed easily with the detector.

6.2 Humidity vs Accuracy

The MGD will function correctly at high relative humidity (RH) levels of 50% or greater, but its accuracy and sensitivity may be reduced. Lower humidity is preferred.

6.3 Moisture filter

The replaceable moisture cartridge filter removes much of the moisture from the sample and is designed to enable users to quickly assess the filter daily life-span by visual inspection. A new dry cartridge will be bright blue in color, and is shown on page 7. The moisture cartridge will turn pink as it removes moisture from the air. As it changes color, the filter cartridge is still within its useful life, but will degrade further to a clear white color if continually used in high humidity conditions or if water is present. To maintain optimum filter performance we recommend that you change it or clear it of moisture when the color changes to light pink.

The useful life of the filter depends upon the relative humidity (%RH) of the working environment. For example, on an average dry day, the %RH is roughly 20%, and in this case the filter should last between 4-6 hours. If the relative humidity increases to 50% RH, the single cartridge might last only 2-3 hours. If the humidity increases to between 50-90% RH, the filter may only last one hour.

With the MGD-2002 field replaceable system, filters can be changed within seconds, or cleared and reused within minutes. Refer to page 34 for instructions on how to change the filter.



Spent Cartridge

Dry Cartridge

The internal filtration material has a limited useful life, and SPX Radiodetection strongly recommends that the MGD is returned for calibration once a year. During factory recalibration, the moisture cartridges are cleared or replaced, and other filters have their filtration media changed. Refer to page 35 for a list of all the value-added benefits that are included in a factory recalibration.

6.4 Power supplies

The MGD-2002 is powered by a replaceable, rechargeable nickel metal hydride (NiMH) battery and comes supplied with a universal AC/DC adapter, AC charging lead, and 12 volt DC charging lead for use with a vehicle cigarette lighter socket.

6.5 Charging the battery

Charging from a completely dead battery will take approx 2 hours and should last for approximately 6-8 hours of run time. While charging, the battery will heat up and become warm. As the sensor is sensitive to temperature changes it will be necessary to **wait approx 20 min** for the battery temperature to return to normal before using the device.

Note: It is not possible to use the MGD-2002 during battery charging as the detection capability is automatically disabled when the battery charger is plugged in.

Note: The battery is equipped with a temperature sensing

element to ensure the battery will not overheat during the charging cycle. If the ambient temperature is too high, battery charging may shut off prematurely. Ensure that the MGD-2002 is charged away from any heat sources.

6.6 Charging the battery using the universal power supply.

1. Plug the AC charging lead into the AC/DC adapter and plug the other end into a standard power outlet
2. Plug the DC adapter lead into the charging connector located on the right hand side of the MGD-2002

Note: When the charger is plugged into the MGD-2002 the LCD will illuminate and display the battery recharging symbol.



Once charging is complete the symbol will change back to a plug

6.7 Charging the battery from a 12VDC auto adapter

1. Plug the auto adapter into the vehicle cigarette light socket
2. Plug the output jack into the charging connector located on the right hand side of the MGD-2002.

6.8 Replacing the battery



Caution - Do not mutilate, puncture, or dispose of batteries by placing them in a fire. The batteries can burst or explode, releasing hazardous chemicals. Discard used batteries in accordance with the battery manufacturer's instructions and your local regulations.

1. Lay the device face down on a flat surface and, using a flat headed screwdriver, turn the battery cover retaining screw 1/4 of a turn counterclockwise and remove the battery-housing-cover
2. Lift out the battery and gently pull up the battery connector lead.
3. Before installing the new battery, attach the three pin connector to the circuit board ensuring it is connected in the correct orientation.

Note: Connecting the battery incorrectly even for a second will destroy the circuit board.

4. Ensure that the battery is fitted in the correct position and that it lies flat in the housing.
5. Install the battery cover taking care to avoid pinching the wires. Tighten the retaining screw 1/4 turn clockwise.



6.9 Button functions and operation

The MGD-2002 features membrane buttons, and has a large multi-function liquid crystal display (LCD). Each button has a raised embossed edge that is designed to be felt by a user even when wearing protective gloves. When they are pressed, the buttons make a noticeable “click” that is both felt and heard. The following is a description of each key on the MGD:

CONTROL

BUTTON DESCRIPTION

(I/O) ON/OFF



The ON/OFF button supplies power to the device. Once switched on, the device will initialize, then conduct a 60 second power on self test (POST).

BACKLIGHT



The light button is used to switch the LCD backlight on and off. By default the LCD backlight is turned off to conserve battery life. When the button is pressed, the backlight will illuminate and will remain on until the button is pressed again, or the unit is turned off.

SOUND



The sound button is used to switch the audio output of the internal speaker on and off, allowing the operator to listen for the detection of the tracer gas and not have to watch the display. By default the audio output is turned off.

PUMP SPEED



Allows manual selection of various pump speeds to increase accuracy of the sample reading in situations with very small leaks. At slower speeds the unit draws in less ambient air with the sample.

RESET



The Reset button allows the unit to remain powered up while clearing all the internal logic circuitry. When the button is pressed, the device goes through its zeroing routine to determine a new baseline for future samples. Using this button to reset the device is preferred to turning the device off and back on as it maintains power to the sensing elements, thus maintaining sensor stability. Only press this button in a zero tracer gas environment.

A/M



The Mode button controls what is being displayed on the LCD. By default the unit is set to automatic mode (A) and will constantly show what the sensing elements have detected in both concentration as well as time. If the unit is placed in manual (M) mode, the device will continue to draw in samples as normal. However, when the sample button is pressed, the LCD no longer shows time, but will only show what the sensors are detecting at that particular moment.

SAMPLE



(Only available in manual mode) When the sample button is pressed, one sample reading is taken. The device calculates the time it should take for the sample to reach the detector, takes the sample, and then displays the result. The sample button must be pressed for every sample needed.

6.10 Liquid Crystal Display (LCD)

The LCD is a near real-time display of the tracer gas concentration the unit has detected. The refresh rate is slightly greater than ten times every second.



After the unit is switched on. This screen will remain displayed while the processor conducts a power on self test, which lasts for approximately 60 seconds.



The LCD displays the approaching zero symbol upon successful completion of the power on self test or when the unit has just been reset. This display is showing that the unit is setting a zero point of reference.

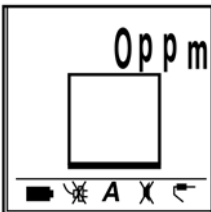

The display upon successful completion of the initial zeroing routine. This screen will be displayed until the sensor elements sense the presence of a tracer gas. The real time graph is updated once per second and shows 60 seconds of history.

6.11 Display status icons

There are five small icons shown at the bottom of the LCD screen. The icon as well as its function is displayed below. The icons are listed in the order in which they are displayed on the LCD, from left to right.

NOTE: A function that has been turned off, will have an X through its icon.

ICON



BATTERY STATUS

This icon gives a visual indicator of the relative life-span remaining on the battery. When the battery level drops below 1/4, a warning beep will sound. The unit will automatically shut off when the empty battery icon is shown



RECHARGE STATUS

This icon is either displayed, or crossed out. If the unit is recharging, the icon will change to a lightning bolt and back to a plug when charging is complete.



MODE

Shows whether automatic (A) or manual (M) mode is selected. The default is automatic.

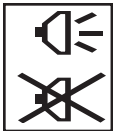

SOUND STATUS

By default the speaker is disabled to conserve battery power and the speaker symbol will initially have an X through it. Pressing the speaker button once removes the X and enables the audio out circuitry.

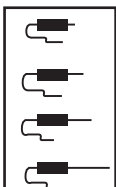

PUMP SPEED

Pump speed can be adjusted for use in certain sampling situation. Pressing repeatedly will slow the pump until it returns to normal speed.

7.0 Tracer gas leak locating for piping systems

7.1 Assumptions:

- You have read and understand all safety information expressed or implied in this MGD-2002 Instruction Manual as well as your local safety codes and requirements.
- You have pinpointed the location of the system under ground
- You have emptied the system of liquid
- You are able to inject helium at the low end and provide a temporary vent at the other end to allow rapid filling.
- You can drill holes in the concrete every 3 feet (1meter) or so
- You are using 100% Helium or 4% Hydrogen as a tracer gas.

7.2 Applicability

This method can be used on **any** piping system, large or small that can be emptied and filled with tracer gas. The gas will escape from the system at the leak and be easily detectable at the surface of the ground.

7.3 Effects on subscribers

With this method of leak locating the effects on the subscribers is dependant on the type of system being checked. In the case of a municipal water or gas system, subscribers should be notified according to normal procedures. Additionally, on water systems subscribers along this system should be instructed not to open a tap during the leak detection process. There is no danger from the gas but large amounts of tracer gas would be lost. Other system types may not require any notification.

7.4 Preparing to leak locate

Leak test

Prior to leak locating you must actually determine you have a leak. Performing a hydrostatic leak test on water systems will confirm that you have a leak in the piping system and give you an idea of how big the leak is. Pressurized air systems may show a significant pressure drop or difficulty maintaining desired pressure. Other systems may require other methods of leak determination.

7.5 Locate the system

Locate and mark the piping system path in the projected search area, noting any recent construction or ground shifting in the area that may have caused damage to the piping system. (There are a large variety of pipe/cable locators available from SPX Radio-detection. Please contact SPX Radiodetection sales or customer service to purchase a locator for your application.)

7.6 Empty the system

In the case of a liquid filled system. Drain the liquid from the system. It is not necessary to have the system completely dry but if the leak is under liquid the tracer gas will need to push the liquid out prior to exiting the system. Smaller piping such as heating systems (approx. 1 inch or smaller) may require using the tracer gas or compressed air to push the liquid out.



Caution - Compressed Gas Contains Energy. Be careful around pressurized systems: loose parts may be ejected with high velocity if the pressurized system bursts.

7.7 Filling the system with tracer gas

Attach the tracer gas. The key words from here on are “Don’t Rush”. Saturating the ground or the underside of a concrete pad with tracer gas will make it difficult to pinpoint the leak. The tracer gas will filter through concrete and pavement “slowly” and this can cause a plume to build up under the concrete and when it does come through it will be in a much larger area. In cases where there is substantial dense material such as concrete or pavement over the piping system, it may be necessary to drill holes every two to three feet over the pipe to improve the search results. (For longer runs of piping with larger leaks under concrete or pavement every 5-8 feet will narrow the search area.) These holes become vents and allow for better pinpointing. Systems that are imbedded in concrete will not require holes. However, it will require time depending on the depth of the concrete.

Keep in mind that the tracer gas is lighter than air and wants to rise. Start in the lowest point of the system as possible to allow

it to go up hill. Additionally, you will need to vent the other end of the system until tracer gas can be detected at this vent. This will ensure you that the tracer-gas has reached the leak. Once detected at the vent, the vent can be closed and the system can be pressurized with tracer gas. Approximately 3-5 PSI to start but can be increased safely up to 10% of its normal working pressure if the leak is not found. (The helium molecule is much smaller than a water molecule and will exit a leak faster and easier than water will.) The best approach is to start with lower pressures and increase slowly. Remember: too much helium to start can make a leak easy to find (large area) but hard to pinpoint. Also note that helium will travel in the path of least resistance. (It will find the easiest path it can, and that path may not be where you would expect)



Caution - Never pressurize any system above its working pressure.

7.8 How much tracer gas?

Calculate the volume

Area = πR^2 note Radius (R) in ft

Volume of system (cu ft) $V_{sys} = \text{Area (sqft)} \times \text{Length (ft)}$

Example: 500' of 2" dia pipe

$$(3.142)(0.084)^2 = 0.022 \text{ sq ft}$$

$$.022 * 500 = 11 \text{ cu ft}$$

In this example 11cu ft is the total volume of air inside the pipe.

Note again, it is not necessary to get the pipe to 100% tracer gas concentration. In most cases 5-10% is adequate for leak locating.

Now lets calculate the volume of air inside the pipe when we increase the pressure to 5 PSIG. Building upon the previous example:

Total cubic feet required at 5 PSIG

$$V@ 5PSIG = V_{sys} * ((14.7 + 5) / 14.7)$$

$$V@ 5PSIG = 11 * (19.7 / 14.7)$$

$$V@ 5PSIG = 14.74 \text{ cuft (with no leaks)}$$

At 5 PSIG you would need only 1.47 Cu ft to reach 10% helium in 500ft of 2" dia. pipe with no leaks. In a small system such as this, building the pressure using the tracer gas is perhaps the easiest way to increase and maintain the pressure while keeping the tracer gas levels elevated.

A typical tracer gas tank contains 240 standard cubic feet of tracer gas when full. At a constant flow rate of 30 SCFH, a full tank will keep adding tracer gas to the system for approximately 8 hours.
 $240/30 = 8\text{hr}$

Once the system has been filled and tracer gas is detected at the vent. Close the vent and begin to build pressure. Continue to add tracer gas to the system as it will keep the concentration elevated.

7.9 Very large piping system (12" or larger) or tanks

There are additional challenges in larger piping systems and tanks. Getting enough tracer gas to saturate the system can be a difficult one. This can be easily accomplished by emptying a full tank of tracer gas into the system to get the concentration of gas up rapidly. Then provide additional tracer gas along with compressed air to build the desired pressure. Remember it is not necessary to achieve 100% concentration in the system. That would be a waste of tracer gas. 5-10% is certainly adequate for leak locating as the MGD-2002 is capable of reading Helium as low as 25ppm (1%= 10,000ppm).

Another challenge for very large diameter pipe (> 2ft) and tanks is that it may be necessary to provide some form of air movement inside the piping system as the tracer gas will want to concentrate near the top of the pipe. This can be accomplished using a fan inside the piping to provide mixing.

7.10 Estimating charging times

The charging times, pressure used, and the amount of tracer gas needed are dependent on the size of the pipe and the expanse of the piping system being tested. Additionally, the size of the leak and the material over the pipe (loose earth, clay, concrete, pavement, vinyl sheeting) affect the time for the tracer gas to reach the surface of the ground. Unfortunately with all these variables it is difficult to determine how long it will take for the tracer gas to reach the surface of the ground.

7.11 How long to wait

The system is filled with tracer gas and we know that the leak is allowing tracer gas to rise to the surface. How long this will take is dependent on several factors such as: the depth of the piping system, what material (loose earth, clay, concrete, pavement, vinyl sheeting) is used as backfill and in the way slowing the tracer gas as it rises to the surface of the ground. (The denser the material the slower the progress of the tracer gas to the surface) It is virtually impossible to give equations that will help you calculate the time needed as the conditions in the ground are seldom known well enough to make calculations useful. Although there are some basic rules and the majority of cases the waiting time is between 20 min (2-3 feet deep beach sand) and 2 hours (>6 feet deep gravel) with additional time added for concrete or other dense materials.

- Materials like vinyl sheeting are non-porous and are very difficult to permeate and may require holes to allow a measurable amount of tracer gas to escape
- Thick pavement or concrete may add more than one hour to waiting time. This extra time can be avoided by drilling holes to allow the tracer gas to vent to the surface.
- The deeper the pipe is buried in the ground the longer it takes to come to the surface.
- Higher water content in the soil will slow down the gas.

7.12 Leak locating (basics)

The highest concentration of tracer gas will be along the system path with the highest reading directly over the leak. However cracks in concrete or pavement and differences in material density

(soil) will allow the gas to escape more readily in those areas. A concentration of gas found several inches away from the marked system is due to the gas taking the path of least resistance. But is an indicator that you are getting close. The tracer gas will rise from the leak in most soil materials in an inverted cone shape. When it reaches a denser material such as concrete it will slow its upward travel and spread (plume) thus too much Helium too fast can make pinpointing more difficult.

7.13 Preparing the MGD-2002 detector

Assemble the black tube of the foam covered handle to the control unit, attach the ground probe (yellow stick) to the handle. Turn the detector ON and allow it to complete its 60 sec self-test. The detector should now read "0". Using the detector at its default settings is best for this type of leak locating. Changing pump speed or using manual mode is not recommended in this situation.

7.14 Looking for the leak

Start at the tracer gas feed point and begin to survey the system by placing the rubber cup at the end of the ground probe directly on the ground over the system and allow a few seconds (15-20) for the sample to reach the internal sensor. Then proceed along the system surveying at intervals of 3 feet or less. If you have not found the leak(s) on the first pass of the system, turn around and survey the system in the other direction.

7.15 Repair the leak

Once found take appropriate action to repair the leak and then test the system to see if there are additional leaks. You should not assume there is only one leak. It will save a lot of time in the long run by taking the time to check.

7.16 Empty the system of tracer gas

Warning: Relieve the pressure prior to disconnecting equipment. Remove the gas injection equipment and open the valve used as the injection point. Slowly open the isolation valves at the lower end of the system to let the system fill slowly. Leave the injection point valve open until all the tracer gas has left the system. (Follow proper safety procedures for filling empty piping.)

7.17 Things to Note:

- Do not suck up water into the unit (damage will result)
- Do not plug the battery in backwards (damage will result)
- Allow the MGD-2002 to normalize to the temperature of the search area before turning it on. Rapid changes in temperature can cause condensation to build up on the sensor shorting it out and requiring factory repair in most cases.
- Sweep or vacuum dirt/dust away from drilled holes in pavement or concrete.
- Rapid movement of the control unit may produce false reading. (hold the control unit basically horizontal.)
- The ground probe has an additional filter inside the yellow section protecting the unit the needle probe does not.
- Continuous counting up of the detector is an indication of a clogged internal filter and will require factory replacement of internal filtering.
- If a constant reading of 25-50% is displayed with no helium present it may be necessary to press the Zero button to re-zero the detector.
- The humidity (moisture filter) cartridges can be dried out and re-used. Placing them in an oven at 200°F for about an hour will turn the crystals blue again. Or passing dry Nitrogen through them for about 10 min using the handle, needle probe and moisture clearing adapter.

8.0 Tracer gas leak locating for pressurised cables

8.1 Assumptions:

- You have read and understand all safety information expressed or implied in this MGD-2002 Instruction Manual as well as your local safety codes and requirements.
- You have pinpointed the location of the system under ground
- You are able to inject helium at the central office or valve points closest to the leak.
- You can drill holes in the concrete/pavement every 3 feet (1 meter) or so
- You are using 100% Helium or 4% hydrogen with 95% nitrogen mix as a tracer gas.

8.2 Applicability

This method can be used on **any** pressurized cable system, that can be fed with tracer gas (Helium or Hydrogen mix). The gas will escape from the system at the leak and be easily detectable at the surface of the ground.

8.3 Locate the system

Locate and mark the cable path in the projected search area, noting any recent construction or ground shifting in the area that may have caused damage to the cable system. (There are a large variety of pipe/cable locators available from Radiodetection. Please contact Radiodetection sales or customer service to purchase a locator for your application.)



Caution - Never pressurize any system above its working pressure.

8.4 Charging the cable with tracer gas

Buried cables are charged with helium/hydrogen at the valve points closest to the leak, on the air source side of the leak.

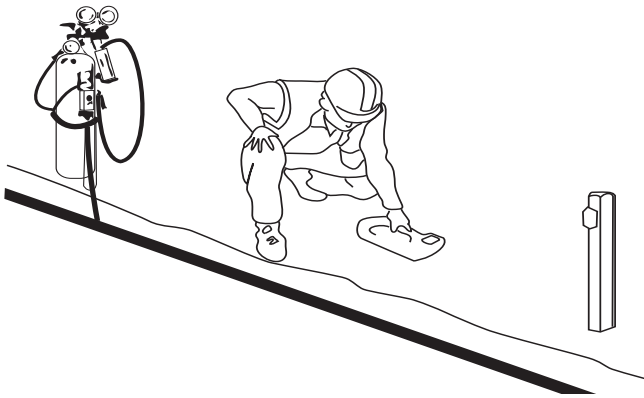

Charging cables

We suggest that the cables be charged from the central office unless a section leak has been identified by graphing the leak. Attach a bottle to the manifold or the pipe/distribution panel and meter the gas into the cable as directed for a minimum of several hours or overnight when possible. This will allow the gas to completely saturate the cables and rise to the surface where it can be readily detected. The tracer gas can then be detected with the MGD-2002 without the need to bore test holes.

Note: Tracer gas will diffuse to the surface through loose soil faster than through compacted or frozen soil.

The highest concentration of helium/hydrogen will be along the cable path, with the highest reading directly over the cable leak. Before using the MGD-2002, mark the path of the cable. Precise cable location can be accomplished while the cable is being charged with tracer gas.

8.5 Charging underground cable systems with tracer gas from the central office.

To find leaks in underground systems, feed the tracer gas from the central office pipe or distribution panel.

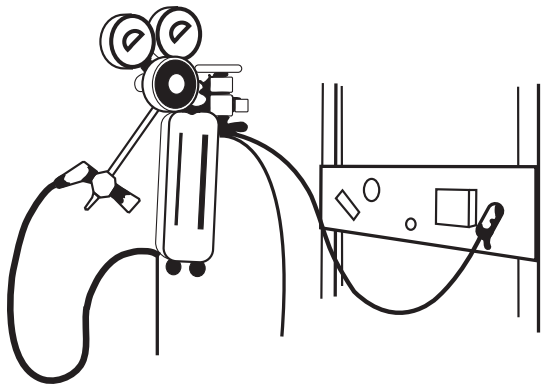

Charging a cable or air pipe system

When applying the tracer gas to a distribution panel use the Model 526 & 530 for panel applications. If you do not use the model 526 & 530, or a locally assembled equivalent, the cables may not all be charged with the tracer gas.

Tracer gas will escape from faults in manhole or duct structures once the system is properly charged. Tracer gas will rise to the top of the manhole and out through the lid where it can be detected .

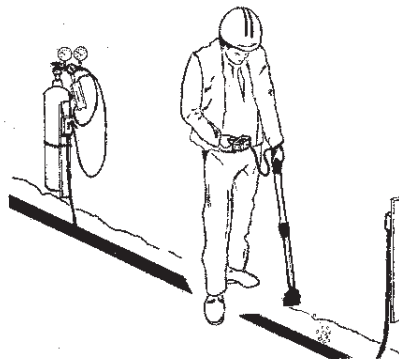

Searching for tracer gas

8.6 Directly charging the cable.

When applying the tracer gas directly to a cable refer to the chart (page 31). This chart shows the amount of time needed for the helium/hydrogen to flow to the suspected leak location. This chart should be used whenever tracer gas is introduced directly into the cable. This applies to both direct buried and underground cable types. You will need the following information before using the chart:

- a. Cable type and gauge
- b. Estimated distance to the leak (DTL) established through analysis
- c. Total length (TL) of the cable section from the tracer gas feed point to the bleed valve. If analysis cannot be accomplished easily due to the lack of recent cable pressure monitoring data consider DL and TL to be the same length, usually the end of the cable run.

A second method for determining cable filling times uses the chart (page 32). This method does not account for the gauge and resistance.

- a. Determine the amount of flow in the cables you wish to charge by using one of the following methods:

- (i) Observe the panel-mounted flow rater in the central office

- (ii) Manually read the flow rate into a cable with a portable flow rater at the central office distribution panel.

- b. Determine the outside diameter of the cable from the cable charts or by manually measuring the cable diameter.

- c. Find the cable diameter on the left hand column of the table. If the exact diameter is not shown, use the next larger one.

- d. Find the flow time per thousand feet of cable by looking down the "Flow rate" column and across the cable diameter row. If the flow rate into the cable is greater than 10 standard cubic feet

per hour (SCFH), divide the number found in the column for one SCFH by the flow rate. The result is the number of hours per thousand feet for that flow rate and cable diameter.

- e. Multiply the time found by the length of cable you want to charge. This is done in number of thousands of feet. The result is the total amount of time required for the helium/hydrogen to flow from the entry point to the desired end point.

Example:

- 1) The cable flow rate at the bypass is 7 SCFH. This will push the helium/hydrogen 4200 feet from this reading point.
- 2) Cable diameter is 2.35 inches.
- 3) Go to the line for 2.4 inches in the left column of the table.
- 4) Go across to the column titled 7". Your flow time per 1000 feet is 2.24 hours
- 5) Multiply 2.24 hours by 4.2 (number of thousands of feet) to find your total flow time of 9.41 hours. This is the time it will take the helium/hydrogen to flow from the reading point to a point 4200 feet distant in the cable.

8.7 Direct Buried Cables:

- (a) Introduce helium/hydrogen at the valve point closest to the area of the suspected leak.
 - (i) Attach a model 530 helium flow controller to the helium/hydrogen tank regulator (see the "530 helium flow controller operations manual").
 - (ii) Attach the inlet hose of a model 526 portable flow rater to one of the valves at the end of the model 530.
 - (iii) Attach the outlet hose of a model 526 portable flow rater to the pressure valve of the system to be charged. If the hose of the model 526 is not long enough to reach from the regulator to the valve on the cable, add additional lengths of pressure hose.
 - (iv) Set the pressure gauge on the tank regulator to 50 PSI. The resulting flow into the system will be approximately five SCFH of tracer gas. This will register on the model 560 portable flow rater as approximately two SCFH of air or five SCFH of tracer gas. These readings indicate that the charging process is correct.
- (b) Refer to Appendix A, or the cable filling times chart at Appendix B, to determine the time needed for the helium hydrogen to flow to the point of the suspected leak.

Note : When charging direct buried cables allow extra time for the tracer gas to escape from the cables and rise up through the ground.

A typical tracer gas tank contains 240 standard cubic feet of helium or hydrogen mix when full. At a constant flow rate of five SCFH, a full tank will keep adding tracer gas to the system for approximately 48 hours.

8.8 Underground cables:

- a. Introduce tracer gas at the meter panel in the central office that feeds the leaking cable.
- b. The tracer gas will flow into the underground cable from manhole locations or riser pole valves instead of the central office. This may reduce the charging time.
- c. Introducing tracer gas directly into an underground cable from a central office is accomplished as outlined on page 22.

8.9 Charging air pipe systems

Introduce tracer gas into the pipe system at the pipe panel in the central office. Find the outlet side of the pipe panel and flow helium/hydrogen into the pipe at five SCFH.

- a. Place the tracer gas tank close to the pipe panel to be charged. Ensure the tank is secure.
- b. Use a model 530 helium flow controller and model 526 portable flow rater as described in the same way as for direct buried cables.

Note: To determine the number of hours of tracer gas available from a tank, divide the number of standard cubic feet (SCF) remaining in the tank by the flow rate in SCFH.

For example: If the tank regulator shows 150 SCF and you are using a flow rate of 5SCFH, the number of hours of flow would be $150/50 = 30$ hours.

Tracer gas will travel to the end of a normal pipe run (approximately 30,000 feet) in five or six hours. Additional time should be allowed for the helium/hydrogen air mixture to permeate the pipe system beyond the manifold points. We recommend that the charging is started at least 18 hours before samples are taken.

If you want to survey a complete system, charge the pipe from the central office manifold. This allows the tracer gas to completely permeate the cables between the central office and the first manifold location.

8.10 Underground system

If you are surveying a complete pipe system, begin your sampling at the central office vault. It is advisable to check the central office vault plugs and other plant before proceeding with the outside survey.

At the manholes, set up work-area protection according to local practice.

Without removing the manhole cover do the following:

- a. Switch on the MGD-2002 and following the startup cycle, insert the extension tip of the probe through one of the holes in the manhole cover.
- b. Take a sample and record the result.
- c. Take a second sample on the opposite side of the cover and record the result.
- d. Proceed to the next manhole and repeat the procedure.

Survey all the manholes in the projected search area and record the results

Return to the manholes with the highest percentages of tracer gas readings. When entering manholes always follow local safety practices and search for leaks using the SPX Radiodetection Model1805 Multisonic translator/detector.

If no faults are found in the manhole, check the ducts using the MGD-2002. Do this using the needle probe extension tip. Insert the probe into the duct as far as you can, taking care not to get moisture into the unit. Take a sample and record the result. Examine and clean the probe tip, if necessary, after each sample.

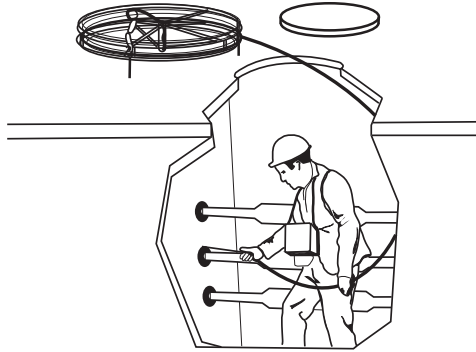

Using duct probe with multisonic tip to pinpoint leaks in conduit

If tracer gas is detected in a duct the SPX Radiodetection Model 1802 mini duct probe may be used to establish the exact location of leaks between manholes (fig 9).

If pressure leaks are not found in the manholes or adjacent ducts, the pressure leaks may be in riser cables or riser cable plugs.

8.11 Leak Locating tips;

- Locate and mark the cable path in the projected search area
- Ensure the rubber collection cup is placed on the ground directly over the path of the cable during the "sample" and "read" cycles
- Samples should be taken approximately every three feet over normal soil and less than three feet over compacted soils
- Frozen ground may cause tracer gas to migrate a considerable distance from the actual leak
- It may be necessary to make holes at curbs or road expansion joints to help the tracer gas to rise to the surface
- When tracer gas is detected, continue to sample the adjacent area until you determine the highest concentration of the tracer gas. Boring holes with a t-bar drill may be helpful at this point. This location will be directly over the cable fault.

**GAUGE
APPENDIX A**

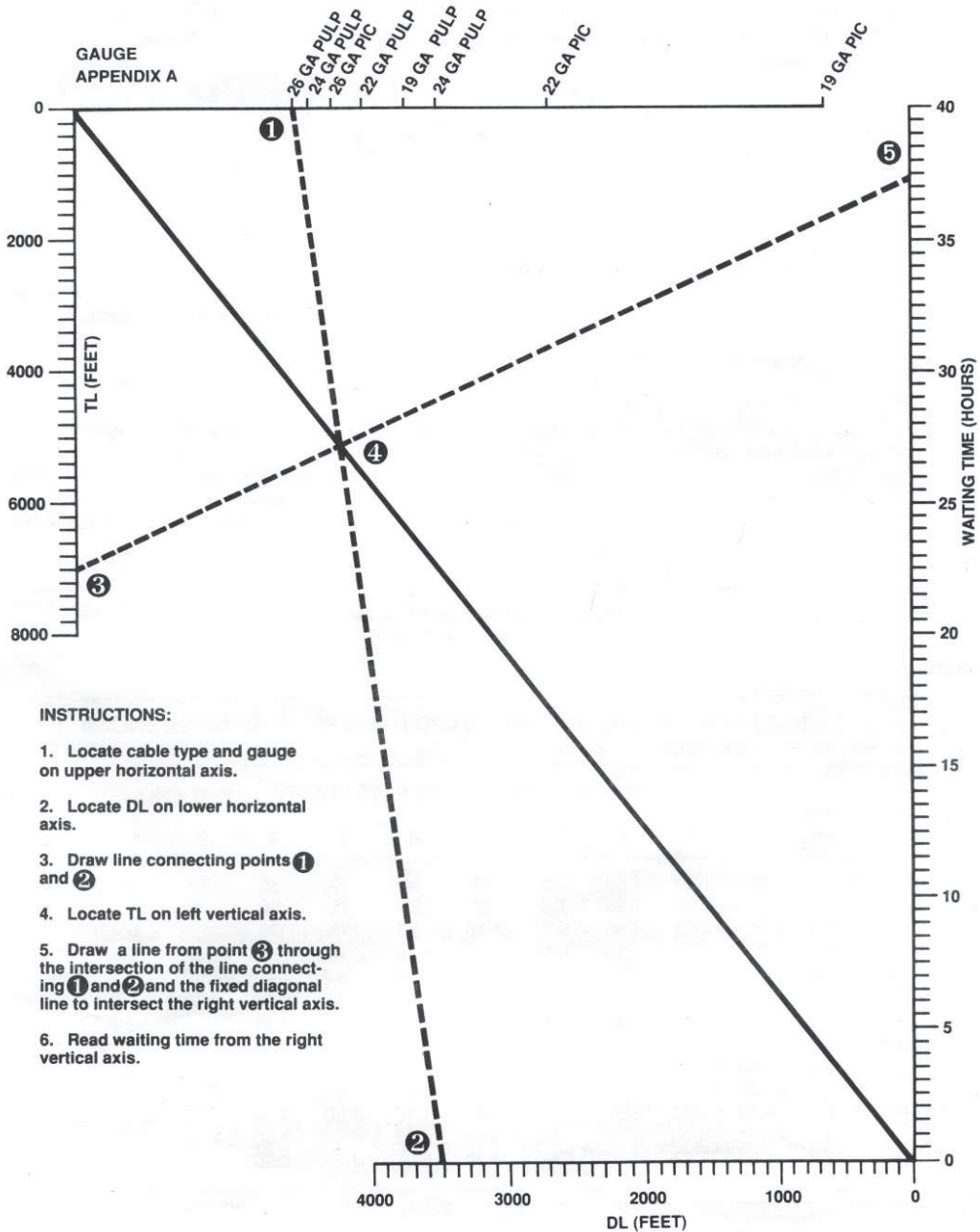

INSTRUCTIONS:

1. Locate cable type and gauge on upper horizontal axis.
2. Locate DL on lower horizontal axis.
3. Draw line connecting points 1 and 2.
4. Locate TL on left vertical axis.
5. Draw a line from point 3 through the intersection of the line connecting 1 and 2 and the fixed diagonal line to intersect the right vertical axis.
6. Read waiting time from the right vertical axis.

Approximate Cable fill times

Approximate cable fill times based upon head end flow rates stated in hours per 1000 feet										
Cable diameter in inches	1	2	3	4	5	6	7	8	9	10
1.0	2.75	1.4	1.0	.75	.55	.50	.50	.35	.30	.25
1.2	3.9	2.0	1.3	1.0	.80	.65	.55	.50	.45	.40
1.4	5.5	2.7	1.8	1.35	1.1	.90	.75	.70	.60	.55
1.6	7.0	3.5	2.35	1.75	1.4	1.15	1.0	.90	.80	.70
1.8	8.85	4.4	2.95	2.2	1.8	1.5	1.25	1.1	1.0	.90
2.0	10.9	5.45	3.65	2.75	2.2	1.8	1.55	1.4	1.2	1.1
2.2	13.2	6.6	4.4	3.3	2.65	2.2	1.85	1.65	1.5	1.35
2.4	15.7	7.82	5.25	3.9	3.15	2.6	2.25	2.0	1.75	1.6
2.6	18.45	9.2	6.15	4.6	3.7	3.1	2.65	2.3	2.05	1.85
2.8	21.4	10.7	7.15	5.35	4.3	3.6	3.05	2.7	2.4	2.15
3.0	24.55	12.3	8.2	6.15	4.9	4.1	3.5	3.1	2.75	2.45
3.2	27.9	14.0	9.3	7.0	5.6	4.65	4.0	3.5	3.1	2.8
3.4	31.5	15.75	10.5	7.9	6.3	5.25	4.5	3.95	3.5	3.15

9.0 Serial port (if equipped)

A serial port can be added to the MGD-2002 Contact customer service for more information.

Data is sent at 57600, n, 8, 1 in ASCII format with a carriage return (0x0D) and line feed (0x0A) after each value so it reads out fine in Hyper Terminal. The values are bounded by spaces so a file capture can be done and then imported into a spreadsheet with space delimiting. Values are sent in Automatic mode every 100ms

10.0 Maintenance

10.1 Cleaning & inspection

Instrument:

Clean away any debris or moisture accumulation with a clean, soft, damp cloth being careful not to scratch the protective LCD lens cover. Check the exhaust ports on the top right side of the unit (small brass fitting) for any obstructions.

Ground Probe/Collection Boot:

Clean with compressed air or with soap and water to remove mud and debris. Dry the collection boot thoroughly when done. Clean the small filter in the collection boot with a small brush as necessary.

Small Probe Tip:

Clean with compressed air or with soap and water to remove mud and debris. Dry the tip thoroughly when done.

Moisture Filter cartridge:

Check the filters in the handle before every use. If the cartridge is pink or whitish in color replace the cartridge following the instructions below. The handle can be cleaned with soap and water as long as the silica filter is in place and the knurled cap section is tightened firmly.

Note: Do not allow water to enter the wand - if water is encountered check the color change indicator in the wand handle!

10.2 Moisture Filter replacement

In order to replace the Moisture (silica gel) filter, firmly grip the filter handle with one hand and turn the knurled cap assembly counter clockwise until they separate. Once the cap assembly is removed, push the filter out by using the viewing holes in the handle.

To restore these cartridges to a dry deep blue useful condition.

Method 1

Backflush the hand held probe with compressed “Dry Air” or Dry Nitrogen. Use the Needle Probe connected to the front end of the probe handle and the clearing adaptor assembly connected to the hose. The needle probe must be installed in order to defeat the one way check valve and allow air to flow back through the filter. This process will take approximately 10 minutes per moisture filter Cartridge to turn them back to a deep blue color.



Method 2:

Place the moisture filter cartridges in an oven at a maximum temperature of 200°F for approximately 60 minutes. This method shortens the useable life of the cartridge.

Note: Overheating will deform the cartridge.

11.0 Calibration:

The MGD-2002 is a precision measuring device that requires factory calibration in order to ensure continued and sustained optimum operating performance. The amount of time between calibration cycles is dependant upon the environment in which the device is to be used, the end user's criteria for the equipment, and the amount of time the equipment is used throughout the year.

If you frequently use this device, or extremely high accuracy is required, the unit should be calibrated a minimum of once per year. If, however, the device is used infrequently or the accuracy is not as critical, factory recalibration can be delayed to as much as every two years.

Sending the unit back for calibration is not limited to the annual or biannual calibration cycle chosen. For example, the user may suspect inaccurate operation that may be the result of the filters or plumbing being blocked with oil residue, oil vapors, water, dirt, petroleum vapors, grass, and insects or some other foreign material.

During the factory re-calibration, the following value added steps and procedures will be accomplished:

- 1) Inspection
- 2) Light cleaning (as required)
- 3) Moisture cartridge filters replaced (2)
- 4) All internal filter media replaced
- 5) All internal tubing is replaced
- 6) Air volume checked
- 7) Software updates installed (as available)
- 8) Calibration procedure completed

12.0 Frequently asked questions (FAQ's)

Q: Why do sudden movements cause the detector to react?

A: Sudden movements such as rapidly swing the unit from a horizontal position to a vertical position can make the detector temporarily display between 25 & 50ppm . This is caused by air movement disruptions inside the control unit and is normal.

Q: Directly following charging the detector gives false readings where there is no Helium/Hydrogen?

A: The battery heats up as it charges raising the temperature of the air inside the detector above room air, causing false readings. Allowing the unit to cool for approx. 15-20 min. after charging will correct this problem. Opening the battery compartment during charging can reduce this cooling time.

Q: How do I dry the Humidity cartridge without a source of dry air?

A: A tank of Dry Nitrogen can be used in place of Dry air. As another alternative the humidity cartridge can be baked in an oven at no more than 200°F for approx. 30-60 min. We do recommend in application where dry air is not available that you purchase extra humidity cartridges.

Q: Will gasses other than Helium/Hydrogen effect my readings?

A: Yes, other gasses can affect the readings but most are absorbed within the internal filters or have a lower thermal conductivity as compared to air which will have little or no effect on the readings. See section 4.2 on page 4

Q: Will 100% helium/Hydrogen “burn out” the sensor?

A: No. This sensor is not damaged by high concentrations of helium/hydrogen.

Q: Can my MGD be used to locate leaks in natural gas lines?

A: Yes, Contact our customer service department for information

on proper usage in these applications.

Q: Will this detector completely eliminate the need to drill holes in pavement or concrete?

A: No, although it can reduce this need it will not eliminate it. Several inches of pavement will substantially slow the permeation of Helium/Hydrogen to the surface, which can cause pluming of gas under the pavement making it more difficult to pinpoint the leak.

Q: The detector displays a negative zero shortly after taking a reading with high helium levels. What does the mean?

A: The sensor is recovering after being cooled by the high concentration of Helium/Hydrogen in a few moments it will again stabilize and automatically zero usually within one minute. If it remains at a negative zero for more than three minutes, the detector may need to be serviced. Contact customer service.

12.1 Hints:

- You can use a standard Helium balloon (latex) to practice leak locating. The MGD-2002 will detect helium leaking through the surface of the balloon.
- A sample of 100% helium will not damage the sensor.
- Ensure the rubber cup is placed directly on the ground over the path of the system during sampling.
- Start with any suspected areas first. Look for locations where obvious ground shifting of construction work has occurred. For concrete embedded systems look for cracks over or near the system.
- Samples should be taken approximately every three feet over normal soil and less than three feet over compacted soil, pavement or concrete.
- Pipe that is close to the surface <1 ft may require samples to be taken at shorter intervals. The gas has little time to spread. (inverted cone)
- Frozen ground may cause the tracer gas to migrate a considerable distance from the actual leak.
- It may be necessary to make holes at curbs or road expansion joints to help the tracer gas to rise to the surface.
- When tracer gas is detected, continue to sample the adjacent area until you determine the highest concentration of the tracer gas. Boring holes with a t-bar drill may be helpful at this point. The location of highest tracer gas concentration will be directly over the system fault.
- Being able to reasonably repeat a low reading (100 to 1000ppm) is significant. Readings above this are generally significant and easily repeatable.
- Spot reading below 100ppm if “not” repeatable may be due to equipment sensitivity to certain movements or other factors.

13.0 Troubleshooting

The pump seems to be straining and no air is exiting from the outlet port (brass) on the right side of the control unit.

- Check that the handle section and the ground probe or needle probe is properly installed.
- Check to see if the humidity filter is clogged.
- Check to see if the filter at the boot end of the ground probe is clogged
- Contact customer service. This is an indication of a clogged internal filter.

The detector continuously “counts up” without helium/hydrogen present.

- Check to see that the handle section and the ground probe or needle probe is properly installed and not clogged.
- If the unit was recently charged allow it approx. 15 min of cool-off time.
- Allow the unit to run for approx. 10 min and then press “Reset” to zero the detector.
- Contact customer service. This is an indication of a clogged internal filter or an internal leak.

Erratic readings when first turned on, no tracer gas is present. The readings just bounce all over the place from 0 to several hundred ppm and back in rapid succession.

- Contact customer service the sensor is fouled with condensation or is damaged. Requires factory service to correct

Working on a busy street with heavy traffic the detector is giving false reading.

- Place the boot end of the ground probe up in the air as far away from Helium/Hydrogen/Auto emissions and press the reset button. This may be an indication that the catalyst filter built into the base of the handle is no longer functioning properly. Contact customer service.

14.0 Service Information

Should you need to contact us please call our Customer Service Department on (207) 655-8525 or toll free at (877) 247-3797

When returning a unit for factory service or calibration, call the customer service department for a service return authorization number (SRA). The device should be boxed securely and contain contact information, contact telephone number, billing information, and return shipping information. If the device is being sent to the factory for service, a written statement of the problem or symptoms should be included. The SRA number must be on the outside of the package or indicated on the shipping label.

NOTE: Do not ship equipment contaminated with any type of hazardous/harmful substance.

SPX Dielectric

28 Tower Road, Raymond ME.

Phone (207) 655-8525 Toll Free : (877) 247-3797 Fax: (207) 655-8535

Email: rd.sales.us@spx.com

WARRANTY

The Manufacturer warrants that all goods supplied hereunder, whether or not of its own manufacture, will be of the kind described herein or in any specification and drawing approved by the Manufacturer and free from defects in material or workmanship under normal use and prescribed maintenance for a period of one (1) year, with the exception of air dryers utilizing water sealed compressors as well as the compressors themselves which shall be for two (2) years. Neither this warranty nor any other, expressed or implied, shall apply to goods delivered hereunder which have been damaged or subjected to alteration or negligence after delivery. The Manufacturer's only obligation for breach of this warranty shall be the repair, without charge, or the furnishing EX Works Raymond, Maine, of a similar part to replace any part which within one (1) year, with the exception as noted above, from date of shipment is proven to have been defective, provided that (i) the Purchaser shall have notified the Manufacturer within ten (10) days of the discovery of such defect and not later than ten (10) days after the last day of this warranty, and (ii) the Manufacturer shall have the option of requiring the return of the defective material (transportation prepaid) to establish the claim.

The Manufacturer shall not in any event be liable for the Purchaser's manufacturing costs, loss of profits, good will or any other special, consequential, incidental, or other damages resulting from such defects. THERE ARE NO OTHER WARRANTIES, EXPRESSED OR IMPLIED, WHICH EXTEND BEYOND THE WARRANTY SET FORTH HEREIN.

28 Tower Road, Raymond, Maine 04071, USA

Tel: (207) 655-8525 Toll Free: 1-877-247-3797 Fax: (207) 655-8535

Email: rd.sales.us@spx.com www.radiodetection.com